

Università degli Studi di Firenze

**TECHNOLOGICAL INNOVATION AND  
CHANGES IN THE UNIVERSITY:  
MOVING TOWARDS THE VIRTUAL  
UNIVERSITY**



Edited by Antonio Calvani



Firenze University Press

Università degli Studi di Firenze

TECHNOLOGICAL INNOVATION AND CHANGES  
IN THE UNIVERSITY:  
MOVING TOWARDS THE VIRTUAL UNIVERSITY

*Edited by* Antonio Calvani

**Firenze University Press**  
2003

Technological innovation and change in the university: moving towards the virtual university / edited by Antonio Calvani. - Firenze : Firenze University Press, 2003.

<http://digital.casalini.it/fulltext/is.asp?isbn=8884530849>

Print on demand available at <http://epress.unifi.it>

ISBN 88-8453-084-9 (online)

ISBN 88-8453-051-2 (print)

371.3028 (ed. 20.)

Distance learning - Education, Higher - Information technology -  
Communication - Internet

© 2003 Firenze University Press

Università degli Studi di Firenze

Firenze University Press

Borgo Albizi, 28

50122 Firenze, Italy

<http://epress.unifi.it>

*Printed in Italy*

**Introduction**

*Antonio Calvani* .....1

**The Virtual University System**

*Maria Chiara Pettenati, Dino Giuli* .....3

**Towards an Open and Flexible University**

*Camilla Tartoni* .....55

**The University and Virtual Classrooms**

*Mario Rotta* .....71

**Internet as a Support Tool in Face-to-face Teaching**

*Giovanni Bonaiuti* .....121

**Distance Education, Open Learning, and Online Education:  
An Annotated Bibliography**

*Stefania Cecconi (ed.)* .....141



## INTRODUCTION

*E-learning* and *online learning* are expressions of the decisive changes at present under way in Education and Learning. The University is a major role-player in this evolving process. The newly emerging role of the University is directly linked to the rapid developments triggered by the introduction and application of Information and Communication Technologies within the University context. What began in the '90s as the liberation of Learning from the structured physical bounds of classrooms and time limits has now, in the first decade of the new millennium, reached "exploding" point. There are a number of common features such as the massive integration of C.M.C. (Computer Mediated Communication), the expansion and diversification of access, learning communities and personalised learning.

Thus, the virtual, flexible and distributed university has been born. In this context it is becoming more and more obvious how the Internet and the online environment are the "tools of and for change". Indeed, we can definitely state that Distance Education (DE) has progressed to the third generation, to use a classic distinction made by Garrison and Nipper. DE has gone from the one-to-many mode which was typical of the 1980s and predominantly distributive with little or no two-way interactivity, to a many-to-many mode based on tutor-learner interaction characterised by forms of learner sharing and collaboration within the virtual classroom.

The prejudiced view whereby mediated education was, necessarily, of an inferior quality, and was considered to be *cold* and *detached* when compared with face-to-face learning, has been progressively broken down. Today, anyone participating in online learning experiences quickly realises how the "distance" component takes on a new meaning when compared to face-to-face learning environments, since the former can be even more passionate and emotionally intense than the latter which are based on physical proximity.

Nevertheless, despite these positive aspects a number of problems and doubts remain at a time when the desire is to promote the process of change in the University through the use of the networks. First and foremost, there is the problem of cost. It is an illusion to imagine that change, especially in the initial phase, can be made at no cost. Secondly, and linked to the first, is the problem of the strategies to be adopted. Should preference be given to global approaches, promoted from the top, or, rather, should transformation stem from the bottom, by supporting the initiatives of innovative teachers? The first path guarantees the rapid diffusion of standard approaches and skills but, at the same time, at least in the initial phase, requires considerable additional investment as regards infrastructure and widespread training initiatives, which are not always easily and/or readily accepted. In addition, there is also an increased exposure to the risk of failure as the large technological investments of the past few years demonstrate, since they later proved to be inefficient as they rapidly became technologically obsolete. The second approach, whereby the individual entities (departments, etc.) acquire more autonomy, appears to be less risky but is more likely to lead to a greater waste of resources, highlighting academic speciali-

zations and, in time, offering only a minor overall guarantee of rapid, equable and rational development.

It is essential to undertake a thorough investigation of all the elements in play, and evaluate both the pros and cons of the potential specific strategy, in order to pinpoint the eventual distinctions and integrations to be adopted between centralised rationalisation initiatives and areas of peripheral autonomy.

More specifically, what are called for are interdisciplinary analyses which adequately and clearly represent the complexity of the factors involved, in particular the overlapping areas at the different levels i.e. infrastructure and technology, management and administration, communication, methodology and Education and Training – all of which must harmoniously contribute to the efficient and effective functioning of the system.

This book, which grew out of the collaboration between a number of teachers and researchers from the Educational Sciences and Engineering Faculties of the University of Florence, constitutes an initial contribution, which focuses on a number of aspects and questions which are of particular importance for the University as it sets about planning its own strategy for change supported by technological innovation:

- Can we consider the “virtual university” as a system, identifying a macro-model which organically describes all the variables in play? Maria Chiara Pettenati and Dino Giuli (Faculty of Engineering) tackle this problem. They examine the user-centred scenario, the organisational dimension, the communication architecture and the complex question of necessary resources.
- The University is going through specific processes of evolution. What types of models are emerging in the international context? In her contribution, Camilla Tartoni (Faculty of Educational Sciences) dwells on the “journey” of the University towards flexibility and virtuality, i.e., towards models of open, flexible and distributed learning.
- What communicative connotations and dynamics characterise entities such as “the virtual learning space and the virtual classroom”? How does the Learner in a virtual classroom behave, and how does one promote collaboration dynamics? These are the principal topics tackled in the contribution by Mario Rotta (Faculty of Educational Sciences).
- Can I.C.T. improve “from the bottom-up”, starting with some innovative teacher and the needs which are rooted in traditional teaching? This is the question which forms the basis of the contribution by Giovanni Bonaiuti (Faculty of Educational Sciences). He continues by illustrating some examples of the use of the Internet as an environment which facilitates traditional educational activity, as it is used within the Faculties.

The volume ends with an annotated bibliography of the literature on the subject by Stefania Cecconi.

Antonio Calvani

Dipartimento di Scienze dell'Educazione, dei Processi Culturali e Formativi

Università degli Studi di Firenze

e-mail: calvani@unifi.it

# THE VIRTUAL UNIVERSITY SYSTEM

Maria Chiara Pettenati, Dino Giuli  
e-mail: Pettenati@achille.det.unifi.it, Giuli@det.unifi.it

## INTRODUCTION

The increasingly widespread use of the new Information and Communication Technologies (ICT) in every sphere of human activity is both conditional and problematic. While, on the one hand, the use of such technologies is promoted and motivated on account of the potential benefits to be derived, on the other we have to take into consideration the fact that its effective utilisation entails a profound restructuring of the existent systems and processes in cultural, economic, social, political and even technological terms.

Given its crucial role in social development, the educational system – and in particular the university – is naturally led to seek within these new technologies solutions and methods which can make education and training more effective, accessible and exploitable.

During the last decade there have been numerous innovations in terms of the technologies and services developed which have come to number among the tools which can be potentially exploited to resolve many of the major problems of the current educational system. These tools are so numerous, differentiated, and in such a state of continuous evolution that any survey, however necessary and useful, is highly likely to prove incomplete and very rapidly obsolete. At the same time, it must also be said that this field calls for specific skills deriving from multi-disciplinary contributions and an inter-disciplinary methodology which, as is the case in Italy too, are not yet adequately defined or consolidated within the cultural and administrative framework of the educational institutes.

This chapter is designed to propose elements of stimulus for a critical and constructive analysis of the *system of university education*, seeking to delineate a prospective scenario of the *virtual university* system in its various structural components, considering and analysing this by placing the *individual* at the centre. The *subject*, that is the individual in the various roles which he/she will assume within the new system, and more specifically as end user, therefore becomes the keyword, a focus considered indispensable for the achievement of a system which is both innovative and also qualified for the new functions. It is a system which will therefore need to be able to articulate and integrate its offer, its structures, technologies and resources in a flexible, effective and personalised manner, to respond as it must to the individual and differentiated requirements of the end users – the students.

### Information and knowledge

*The value of information and knowledge is not objective, but is closely linked to the subjectivity of the person involved in creating or accessing the information, or in constructing and transferring the knowledge.*

A starting-point for the analysis and definition of a virtual university system, which has already been brought to light at a theoretical level, is the consideration that the value which



we give to information and knowledge cannot be objective. On the one hand we observe that the economy tends to regulate the development of the Information Society, determining the widespread use of the technologies and applications in every sphere of human life, and consequently also that of education. On the other hand, we also observe that this development is based on the assumption of values for *information and knowledge* which, on the contrary, are not, and for a long time to come will not be, defined or even definable (Lévy, 1992). At the same time, it is not possible to talk about information and knowledge and about their potential value, without bearing in mind the role which subjectivity plays within them. More than ten years ago, Marshall McLuhan in the *Global Village* (McLuhan, 1989), drew attention to the comment made by Shannon, the creator of the classic theory of communication – according to whom, *communication is based upon the objective reproduction of information, without taking into consideration the signification factors connected with it*. As a result, such factors are largely not taken into consideration in the current solutions for the transmission and reproduction of information (Shannon, 1963). All the technological developments which have since occurred, nourishing the current development towards the Global Network, are based on this theory.

The signification factors which Shannon speaks of are, however, closely related to the subjectivity of the individual and can be elucidated to introduce concepts and define procedures enabling an organisation, representation and transport of the information appropriate to its subjective and social value (Giuli, 2001b).

In a public address, the sociologist Ralf Dahrendorf confirmed in other words the principle of the centrality of the individual in the development and transmission of knowledge:

“In today’s language we would say that knowledge without information is empty, and that information without knowledge is blind... Information is totally without significance if it does not become knowledge, not through distillation but rather as a result of our mental activity. This is the role which educational institutions can and must have if we want the information society to be transformed into that of knowledge”.

It is clear that the use of the new Information and Communication Technologies, as a means not only of opening up towards a Knowledge Society, but also of training the agents of the Information Society, must not be reduced merely to a fashion trend, but is instead a factor deserving of adequate attention, interdisciplinary study, appropriate development and careful experimentation.

This problem is accentuated when we wish to understand how and in what context these technologies can effectively enable individuals to define and follow through their personal itineraries of knowledge growth, in such a way that these really do become more accessible, exploitable and effective.

In our opinion, the key factor here is that of seeking to analyse the educational system through this approach, so as to be able to provide clues and suggestions for the construction and evolution of the methods, structures and resources of the system which will

enable the provision of an educational offer which is effectively innovative and appropriately specialised, as is to be expected of the virtual university.

As we will discuss in more detail below, in the case of the University to which we are referring here, the *virtuality* derives from the fact that the processes of education and of knowledge construction are defined and realised through the conscious and motivated access of the individual, and the elaboration of the so-called virtual resources – that is, information and knowledge – through the use of appropriate technologies, methods and systems.

Reconsidering the university in these terms, that is as a system which effectively develops and transfers knowledge also with the help of the new technologies, necessarily entails a de-structuring and rethinking of the ways in which the education is planned, provided and evaluated, while at the same time maintaining the specificity connected with the differentiation of knowledge and specialisation which distinguish and qualify the individual universities and organisations.

There are naturally many valid, or apparently valid, reasons why the organisations might oppose not only their evolution towards virtual university systems, but even the mere integration of the new technologies within the traditional educational systems. For each of such objections there is, however, a valid and cogent counter-reply.

As observed by Rory McGreal<sup>1</sup>, to the hypothetical objection: “*We can't afford to do it*”, we could reply: “*And can you afford NOT to do it?*”.

### **Virtuality**

*Information, knowledge and resources are actualised through educational courses, the structures which support these, and the construction and transfer of knowledge, with the deliberate participation of an individual expressing free-will, awareness and subjectivity in the on-line interaction.*

*Virtual*, according to the philosopher Pierre Lévy (Lévy, 1997), indicates the problematic complex, the knot of trends and tensions which accompany a situation and which demand a process of actualisation to generate a solution, a product and a transformation. In this definition Lévy suggests a correspondence between the *virtual* (problematic field), which is realised in the *actual* (the invention of the required solution to the problematic complex) and the *possible* which is realised in the *real* (events within a pre-defined area of possibilities).

In the case in question, information and knowledge are *virtual*; providing *information* does not necessarily imply interpreting this and connecting it to other information in order to make sense, or actualise it, performing a creative act. *Knowledge*, on the other hand, is the fruit of learning and consequently the product of the virtualisation of the immediate experience, while the *practice of knowledge* is the inventive resolution of a problem, and therefore an actualisation.

---

<sup>1</sup> See Glossary and Notes

This approach brings with it many implications which are crucial from the point of view of the changes in role, functions and values typical of the new network economy and society, and which have clear repercussions on the new educational system. The user, that is the individual who acts within the network, becomes a *co-producer* of the information and in the creation of virtual worlds, and an agent of market visibility through his/her operation and interaction within the network (Lévy, 1997). And so we speak less of consumer, and increasingly more of co-producer of interactive goods and services.

*Virtual University* therefore means a system of *information, technologies, tools, methods and resources*, organised and arranged in such a way as to meet users' requirements in the diversification of the latter's subjectivity. The *virtuality* of the university is linked to the fact that the information, knowledge and resources are actualised through educational courses and in the construction of knowledge only through the deliberate participation of an individual who expresses awareness of, and the necessary desire for, interaction within the network in terms of both information and of the collective, and even de-territorialised, intelligence which the network makes available.

### **Objectives and contents of this chapter**

In order to evaluate the state and the evolution of the Virtual University, with reference to the above-mentioned requisites and structural elements, it seems opportune to initially focus attention on three fundamental elements which are at the basis of the reasoning which follows. These are: the *user scenario*, which enables a definition of the range of variation in modes of response which the virtual university should provide for in terms of individual user requirements; the corresponding *requisites* which derive from this in structural terms, that is requirements related to organisation, the methods of production and provision of the education; and the *operational limitations*, which restrict the scope of possibilities on the basis of the contextual situation, and which, among other things, also define the didactic/educational requirements which have to be met.

Conceptually the *virtual university system* should be sketched out starting from the user scenario with its field of variability, the differences in which can be related to all the individual aspects: from the personalised educational objective to the subjective characteristics of the individual persons, through to the individual itineraries of instrumental access.

Only by starting from such an analysis is it possible to define the appropriate and individually suited action and methodologies, the structural functions and actions and the coordinative and support functions which the virtual university system ought to embrace.

In this chapter, after having set up the analysis of the type of user, we shall therefore go on to examine in greater detail the various elements which compose and structurally condition the virtual university system: the *administrative and regulatory aspects*, the *technological platform*, and the *capital of information and knowledge*.

The contribution will conclude with an analysis of ulterior aspects which are also considered fundamental for the realisation of a valid virtual university system; these relate to the connection, co-operation and competition between different systems, which must therefore be re-considered in terms of the implications deriving from the widespread use of the new information and communication technologies.

Before going further, however, we should like to clarify that while the approach adopted constitutes an attempt to tackle and resolve the problems, and consequently a way of achieving the guidelines for an efficient utilisation of the resources available, it does not presume to supply a definitive recipe for the solution of the problem in question. In reference to this, we subscribe to and share the views expressed by Adrian Kershaw (Kershaw, 2000), on the subject of on-line learning systems:

“Traditionally, planning for the implementation of information technology applications in teaching and learning, and in administrative functions, has been linear in nature. The classic planning model used in universities involves five to ten year time horizons. It was honed during the last century in environments of relative predictability. However, that model is now defunct, rendered obsolete by the information technology revolution which now drives very rapid shifts in demand patterns and service delivery methods. Chaos theory provides a more robust, if less comfortable, framework for planning in higher education. [...] The theory tells us that there are periods – often quite long – where predictability does exist and a more traditional approach to planning is appropriate. [...] Thus a bi-model approach to planning and change in institutions is called for. [...] At the same time, in response to an apparently chaotic environment, institutions must implement systems which allow for the development of punctuated equilibrium approaches to the evolution of new programs, services and relationships”.

The themes dealt with here can be inserted within the broader framework of the research activity *B.E.S.T. beyond Internet* (**B**ridging **E**conomy and **S**ociety with **T**echnology beyond Internet), in the Postgraduate Research Course on Telematics and the Information Society (Giuli, 2001a, 2001b).

### THE USER SCENARIO

*The growing differentiation and specificity in the educational demand means that it has to increasingly adapt itself to “just for you” type requirements. The analysis of the educational demand within the present national university system, along with that of the type of user, enables a conceptualisation of the various routes for access to university education suited to the requirements of the individuals. It also proposes “global” operative requisites for their effective implementation which should enable the limitations of the present system to be overcome.*

The opinion is by now widely held that the universities will have to change their attitude, shifting from a federated system which serves traditional students originating from local communities, to become an *industry of knowledge* (Katz, 1998) which serves a vast and differentiated pool of users. It is highly likely that this will be the dominant action of the future, not only for universities and training organisations, but for all the services which are centred on information and knowledge, which thus change from being *knowledge suppliers to knowledge administrators*.

If, on the one hand we are witnessing a continuous increase in the number of people who wish to access higher education services, on the other there is also a growing differentiation in the type of educational demand involved, which is increasingly specific and increasingly more closely linked to the subjective requirements of the individual. Those applying to university are no longer only students from secondary schools, but also a growing number of adults seeking to acquire new skills to improve their professional prospects, or to satisfy the contingent requirements of qualification and specialisation.

The training methods must therefore integrate access and methods of the just in case type, where the students complete their educational curricula within times which are independent of the contextual need to apply a specific knowledge, access and methods of the just in time type, where the students access specific educational programmes when the need arises, and methods characteristic of the virtual university just for you type, in which the courses and educational programmes are tailor-made to meet the requirements of each individual.

### **The evolution of the present national university system**

The realisation of the process of evolution towards the virtual university has to take into account the traditional university system from which it must necessarily develop.

In this respect, it is useful to consider the evolution of the educational offer which is currently available in the present national university system, to which we will refer below for the purpose of highlighting certain specific requirements.

Within the framework of the current reorganisation of university studies at national level, particularly significant is the introduction of the split level degree course – ordinary degree and specialisation – each of which can be followed by a master's degree at the corresponding level. Also envisaged are research doctorates and postgraduate specialisation schools. These courses of study have ordinary curricular characteristics, while featuring a broad autonomy of make-up with other targeted educational offers, closely linked to the demands of the outer world and to the external links which the university system must develop for this purpose.

Essentially, what is envisaged is a university system which is inserted within a broader system of *integrated higher education* which is capable of performing two crucial functions. The first is the activation of the corresponding and necessary connections with the system of professional training – post-scholastic, private, corporate and state. The second important function is participation in the system of ongoing, lifelong education.

The envisaged approach must also be flexible. It should facilitate the individual and differentiated integration, or reintegration, within university courses of those coming either from the world of work, and without necessarily detaching themselves from it, or from non-university educational courses. It should also enable personalised accumulation of the educational modules for different courses of university study, even with a view to the sequential and facilitated achievement of successive qualifications of a professional and/or specialist nature, including postgraduate studies.

Another important objective set is that relating to links with the external world, so that the university system will be able to guarantee a greater and more flexible correspondence

of the educational courses it offers to the actual needs. A corollary of this is the need for a corresponding contextualisation of the university courses within the real working environment, at least in the more professional sectors, so as to favour subsequent entry into this world. This requires the integration of specific training resources originating from the world of work and production in their various useful forms – in-house training sessions, courses held by external experts, the use of educational tools contextualised for specific working environments etc.

The requirements of modularity, flexibility and integration, as already envisaged as the objectives of the university system, reveal the need for a broader diffusion of the solutions to be exploited within the virtual university.

Fig. 1 shows a schematic representation of the global university education offer, interpreted within the context of *integrated higher education*, and set in relation to the entities which combine to define and provide this. This figure is also designed to illustrate the

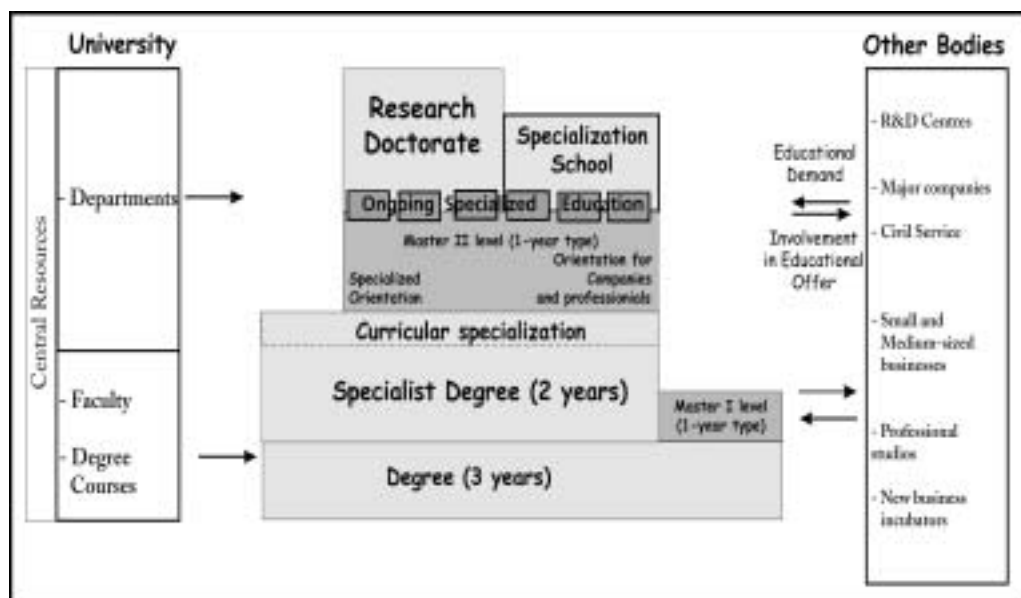

Fig. 1. System of Integrated Higher Education in the University environment

potential overlapping and juxtapositioning of the educational courses with reference to postgraduate specialisation courses, as an example of an achievable flexibility.

### Types of user and routes for education access

An open and permanent system of virtual university must enable a broader and better service to the pool of user categories which it already serves while also enabling it to reach new categories. More specifically, potential types of user – differentiated by the curricular sphere of education – include:

- *Normal students* on university degree courses (basic or specialist curricula) on university postgraduate courses (research doctorates, masters, specialisation schools, advanced training courses);
- *Normal students on professional post-scholastic courses*;
- *Individuals requiring educational courses within a perspective of ongoing training* and also the certification of skills acquired in the workplace (relevant for workers in both the public and private sectors, and for freelance professionals);
- *Students without secondary school diplomas* who intend to pursue studies at the level of higher education;
- *The adult population in its globality*, for the purposes of elective education (life-long learning) etc.

These categories of user, in relation to their specific requirements and individual limitations in terms of available time, could take advantage of mediums which facilitate access to education both full-time and part-time, thus becoming, in line with the contingent requirements:

- *Full-time students on campus*; the new technologies can enable an improvement of the educational offer through online links with off-campus teachers or experts, and as a result of the new learning resources and methodologies available. This is an extremely important application in all the sectors of education and training, while the positive benefits for university courses, including degree courses, have yet to be more fully evaluated;
- *Full-time extramural or off-campus students*; students living at a distance for whom the use of the technologies can prove to be of enormous benefit, being opportunely integrated with periods of presence on campus;
- *Part-time students on campus*; students who are working part-time and who attend part-time courses on the campus (for example in the evenings), who can benefit from the technologies which guarantee greater and more continuous opportunities for learning and interaction with the teachers;
- *Part-time extramural or off-campus students*; these are normally workers employed full or part-time for whom the utilisation of the new technologies is indispensable. This is the potentially largest pool of users (and that most penalised at present), which can draw the greatest benefits from the Virtual Universities, thus avoiding exclusion from university access.

The enormous demand for updating, specialisation and professional retraining which characterises the work market today – and which will become an increasingly constant feature in the very near future – calls for the setting up of educational courses which are accessible to the full-time employed, whatever objectives they may set themselves. We have to make access for the employed to the university possible, in terms both of full-curriculum university qualifications and specific training modules.

These modules (masters, training sessions, seminars etc.), offered using traditional didactic methods, predominantly by private individuals, frequently prove to be excessive in terms of cost, and incompatible for workers and businesses in terms of time schedules. A valid and efficient distance learning network for such users could ensure the appropriate quality, rapidity and personalisation at a decidedly inferior cost.

This simple description of the various user types enables us to envisage the different routes for educational access, and consequently to deduce the varied access requirements on the basis of needs. Clearly, individual requirements have to be set in a one-to-one relation to the structural conditions so as to provide a broad variability of educational offer.

### **Operational requirements**

The above categorisation of user types already highlights certain general requisites which the open and permanent system of higher education ought to be able to satisfy. The implicit complexities, and the necessity to undertake innovative action in order to implement a truly effective *virtual university system* in line with the new requirements, go well beyond what is often encountered in the, albeit stimulating, spontaneous and local initiatives of individual institutes or, as is often the case, of single individuals. These, while undoubtedly valuable, cannot possibly meet the needs of that vast public which is to be addressed, nor suffice for the corresponding organisation of a true system of knowledge access.

What we need, therefore, is a definition of the conditions for the activation of structural interventions of a *global* value, which will subsequently be analysed for each of the elements which structurally condition the virtual university system. Among these, those which are to be considered most important are (MURST 1999, Study Committee F@D):

- the rapid acquisition of a degree of openness and flexibility decidedly superior to that in existence, particularly in terms of the extension of access and the successful exploitation of the educational offer;
- the promotion of the standardisation and inter-operability of the technical and operational solutions of the communication infrastructure and the basic computer resources designed to support the new educational offer – as will be described in greater detail below - bearing in mind the essential recurrent introduction of the products of the ongoing technological and methodological innovation within the sector;
- the development and territorial diffusion of adequate infrastructures and technological services at accessible costs, especially as regards telecommunications networks, paying due attention to the new types of network;
- the diffusion of personal equipment and tools for network access among the students;
- the development of the networks used by the public sector in relation to the demands and requisites connected with the progressive development and changing needs of distance learning programmes;



- the parallel development of the related industrial sectors, combined with the necessary conditions for the contribution of private investments;
- the incisive commitment to education, qualification, professional development and the stimulation of human resources which must necessarily lie behind the transformation of the educational system.

### **The limitations of the present system**

Our purpose here is to highlight certain restrictions or limitations which could obstruct the achievement of the system requisites outlined in the above paragraph. Once again it is the limitations of a global character, which are added to the specific limitations of each of the elements making up the virtual university system, which will be illustrated below.

One initial limitation, of a global nature, is the *degree of familiarity with the new technologies (computer literacy)*. By people here we mean both the users of the educational offer and the human resources normally implicated in the process of introduction of the new technologies for the supply of education within an open and flexible higher educational system.

There are many initiatives in progress at local, regional, national and international level aimed at overcoming this limitation. Among these, worthy of a special mention on account of its importance and its synergetic approach, is e-Europe<sup>2</sup>.

Another limitation is the *shortage of new professional figures* required in the educational centres, and of the various technical figures and those with the necessary organisational skills for the realisation, implementation and management of an educational system based on the new technologies, as well as tutorial figures to provide specific didactic assistance. As will be highlighted below, one effect of the introduction of the new technologies into the educational system is paradoxically the very fact that it will create *new and highly important figures* of intermediary between the users and the global network system, for which, in the current state of affairs, no appropriately established training courses exist.

Another restricting factor is the fact that there is still a very limited awareness of the exceptional *economic and social importance of an open and permanent higher education system*, characterised by flexibility, ease of access, richness of the educational offer, and permeability between different options. More specifically, we observe how frequently there is an assumed identification of higher education with traditional university courses. The latter, as it is generally currently understood, is instead only a part – albeit still of fundamental importance and with a vast density of potential which is not always fully exploited – of a more articulated and diversified system which goes from the post-scholastic to the post graduate and on into lifelong learning etc. (see Fig. 2).

One significant example of the rigidity of the present system is the fact that access to higher education is denied to those who, although of adult age, are without a secondary school diploma, even though their maturity or preparation could be easily ascertained through entrance exams, or through the assessment and valorisation of independently acquired experiences and skills.

<sup>2</sup> See Glossary and Notes

With reference to its principal institutional purposes, the university has difficulty both in responding to the needs of users who can attend little or not at all – and who therefore find themselves effectively performing distance learning with the sole assistance of paper mediums, which are moreover frequently not designed for such purposes – and in satisfying the demands of interaction with the students connected with the didactic function itself and with functions such as orientation.

Even though, partially as a result of these very restrictions, it appears difficult in the short term to elaborate concrete proposals for making the higher education system more flexible and efficient, the required structural transformation is nevertheless increasingly stimulated by the general development of the Information Society in other sectors. In our view, however, the decisive impulse for change is the progressive shift from the centrality of the educational institution to a focus on those who are the recipients of the educational offer – or rather to the individuals and entities which express the need for learning – with a progressive reduction of the spatial, temporal and curricular limitations designed to adapt to the continual changes and to the increasing diversification of educational requirements. In this regard, another aspect of growing importance is the establishment of synergic relations between the public and private sectors.

#### THE STRUCTURAL COMPONENTS OF THE VIRTUAL UNIVERSITY SYSTEM

*The virtual university is considered here in terms of macroscopic components which can be set in relation within the broader framework of the Information Society: the Capital of Information and Knowledge – the individuals and the information resources – the Technological and Instrumental Resources which support users' access and interaction online, and the system of Organisation and Regulation which governs its functioning. The modelling of these elements demands at once planning action and a capacity for rapid adaptation to change.*

Up to now we have been attempting to highlight the central role of the variability in type of user and the related requirements of adaptability within the educational system, so as to be able to proceed to a more detailed and specific analysis of the various elements which can contribute to create an effective system of virtual education.

The use of the new technologies can constitute a major innovative potential to be drawn on for the improvement of the quality and flexibility of education; nevertheless, the achievement of this objective is by no means automatic. The new programmes and educational processes presuppose a re-engineering of the university organisations which demands an active participation, at both operational and institutional level in every university. They also require a capacity for adaptation which implies careful planning, discriminating investments, political support, economic stability, an effective re-engineering of the processes and an appropriate training of the staff. For this reason, there is a pressing need for the production and diffusion of new and appropriate educational models, of technical platforms and of personalised and personalisable systems of interaction.

We believe that the creation of systems of virtual university can promote the *globalisation of educational and training systems*, understood not as a move towards a flattening out of

educational programmes, but rather towards the creation of open systems of learning which, on the one hand join and share the access to centres of excellence through a network operating even at international level, and on the other preserve but also valorise all the richness which comes from diversification and cultural pluralism. In such a way the educational offer of the virtual university can become an important vehicle for the transfer of culture, important both in that it is instrumental in the economic development of the country, and in that it can valorise individual territories and local cultures, in international relations and also in terms of benefits directed towards the country itself.

As stated above, the fundamental elements which have to co-exist and develop in a harmonious and structured manner to contribute to the creation of a *virtual university* are: information, knowledge, technologies, tools, methods and resources. These can also be seen, from a systematic point of view, in terms of the *Organisation and rules* which we mentioned above, the *Technological Platform*, and the *Capital of Information and Knowledge*. Each of these elements, and its respective constituents, will be analysed in greater depth further on in this chapter, in the light of the reading keynote mentioned above.

Fig. 2 represents a schematic diagram of the components of the virtual university in an ideal Information Society system. It illustrates the existence of other structures and institutions, designed to be at the service of the individual and of society, which operate through the same mechanism: exploiting the benefits of the *Capital of Information and Knowledge* – the individuals and the information resources, utilising an *Instrumental System* which supports all forms of access and interaction, and defining a system of *Organisation and Regulation* which governs its functioning.

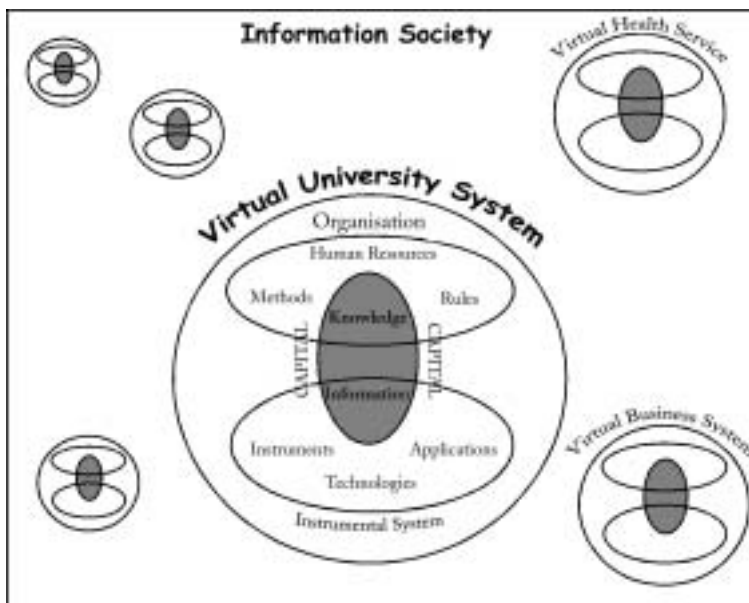

Fig. 2. The Virtual University System

### ***Organisation and rules***

*Like every collective system, the virtual education system requires an internal organisation which operates through appropriate action, structural functions and global intervention, just as it requires rules opportunely adapted to the new systems, while at the same time maintaining an approach which includes respect for consolidated values such as copyright and the certification of skills and knowledge acquired.*

There follows an analysis of some of the administrative, structural and regulatory aspects which are particularly influential and need to be revised. We do not intend to cover all the problems in an exhaustive manner, but rather to provide stimulus for reflection and elaboration.

### **Actions, structural functions and direct intervention**

The organisation of the system of virtual education must have the support of a basic system which guarantees the necessary actions, functions and intervention; some of these may also be performed by electronic means so as to respond efficiently to the requirements of all the users. This also implies the implementation of the appropriate electronic administrative systems, which are beginning to be developed and offered as complete products for the management of the so-called virtual universities.

Some of the actions and functions which the system ought to be able to perform in terms of administration are:

- *co-ordination*,
- *design & planning* these actions relate to the planning of the educational intervention with relevant tools and back-up products which must be able to satisfy the educational objectives and cater for the different types of user accessing the system;
- *guidance & orientation*, these are actions aimed at the analysis of the users' requirements so as to provide the necessary educational offer, and at user guidance for an optimal exploitation of the resources, so as to arrive at a better correlation of educational offer and labour demand. These two actions lend themselves particularly well to being performed with the help of the new technologies, since these enable a more capillary action and surveys within a much broader field, even at international level;
- *promotion*, this action is fundamental for the economy of the new type of university which we have in mind; the purpose of this activity is to put the user in a position to appreciate the importance of education, and to equalise the potential of access for the various individuals through appropriate incentives (for example, by providing special concessions for the purchase of individual work stations, providing access to the university network in a systematic manner, at reduced cost or free, and providing courses of computer literacy, courses for the use of special systems for access for the handicapped etc );
- *internal support & incentivation of staff*, these too are activities which are crucial to the success of the enterprise, and which assume particular importance

especially in the initial phase of the process of integration of the new technologies within the university system. While there are experiments in progress aimed at a systematic approach of this kind, many experiences in this field are still to be considered pioneering. For this reason, it is extremely important that each institute leaves room for the logistic, economic and political support of original and promising planning initiatives in this field. To date the use of new technologies in education has, to a large extent, been left to the initiative of single individuals, with the result that, given the enormous efforts and significant investments involved, few people have wanted or been able to invest in this direction. As has been correctly observed (Battisti, 1993), teachers require incentives of various kinds to take on such activities, to the point that, in certain American universities, distance tutors are already entitled to preferential treatment in terms of salary. It should, nevertheless, also be borne in mind that this potential extra cost would in the long term be compensated by the advantages and reduction in costs resulting from a system with a streamlined, more efficient and accessible organisation;

- *administration*, this function takes into consideration the entire administrative area of user enrolment, workshop registration, special classes, specific exams etc., and the aspect of personnel management as specifically required by the virtual university;
- *support for the use of new technologies*, this function relates to the fundamental aspect of the creation of appropriate support and training centres for all the types of professional skills entailed in the use of the new technologies for the creation of educational courses, modules and contents etc. To date, in our country, the necessary organised and institutionalised structures do not yet exist at national level, while those of the individual universities themselves are few and frequently inadequate. On the contrary, in countries where the new technologies play a more crucial role in educational systems, each university boasts support centres which also cover this function. In our opinion, the existence of such centres – which ought to become an essential in the same way as libraries – is absolutely fundamental if we wish for a rapid and efficient response to the need for change. This type of centre, of an interdisciplinary nature, ought both to house specialised personnel of various kinds – designers, trainers, tutors, technicians etc. (to be described in greater detail below) – and provide the appropriate skills to support the realisation of educational modules and courses, as well as for the development and evolution of the system as a whole;
- *evaluation and monitoring* these are activities aimed at following up and evaluating the educational processes, also in relation to users' expectations, market demands and the subsequent employment of the trained persons;
- *definition of standards and certification*, these are highly important actions which enable the integration and interoperability, even at international level, of vir-

tual education systems which differ from one another, thanks to the definition of appropriate standards (such as educational credits, and all the standards related to the re-utilisation of teaching materials etc.) as will be discussed in greater depth below.



Fig. 3. Organisational Actions and Functions

The actions and functions described above are summarised in Fig. 3. This figure also illustrates the transversal character of certain of the actions and functions outlined above.

### Old rules and new systems

The pervasive use of the network in all aspects of human life will effectively take on the dimensions which have been hypothesised from the very start of the World Wide Web era when the various constituent elements – rules, systems, technologies, resources and methods – undergo a shift in their evolution and come to focus on the individual as the central and conditioning entity in the development of the network. At the same time, an opinion which can validly be shared is that the virtual institutions, and therefore also the virtual university, can only exist and develop if we succeed in finding a viable equilibrium between old rules and new systems (Shapiro, 1999).

### *Copyright and privacy*

The widespread diffusion of information and communication technologies in all spheres of human life – in the countries of the first world – has marked the passage from the industrial to the post-modern era, the so-called Access Era, as acutely observed by the economist Jeremy Rifkin, (2000). According to Rifkin, this epoch is characterised by the

fact that what is of value is not so much the property of a good (tangible, intangible, local or de-territorialised) or of a service, but rather the access to and use of the same. It is the access to information, to knowledge, to the service, to the use of the tangible good which ought to be subject to economic valuation, and not the existence or availability of the information, knowledge, service or good in itself. In spite of the fact that this observation, and the concrete examples which illustrate it, can arouse a certain fear of losing control over one's own experiences, the underlying philosophy could perhaps appropriately be applied to a sphere as important as that of education, where the value must be attributed to the development of intangible activities aimed at increasing knowledge.

In a system where information, knowledge and the actions of individuals within the sphere of knowledge, constitute the principal value and wealth, we have to carefully reconsider the regulatory aspect (Lessig, 1999). It is essential to develop and act with the criteria of the new information economy. It becomes increasingly urgent to resolve the problem of copyright, the concept of which must be extended to contemplate a *flow right*, rather than a *territorial right*, attributing value and therefore taxation to the use rather than the *exchange* (Lévy, 1997). The technologies for tackling the revolution of the economic approach, through which we have to continually monitor the consumption of information on the part of the end user, are already developed and available. In a manner similar to that of the traditional copyright protection system, the new regulations must also extend to finding solutions for the *fair use* of data distributed online in electronic form (Pettenati, 1996; Pettenati et al., 2000a).

Other fundamental aspects in the regulation of the online sphere are those of *privacy* and *security*. These are of less relevance to the analysis being conducted here, but have enormous significance for the development of online activities which involve the bringing into play of personal data. It is nevertheless important to consider the problem of privacy in a broad sense in relation to the processing of personal data, where by the latter we mean the implicit information in terms of contents, online activities, and data relating to the subjective profile of individuals interacting online or who are the subject of study.

### *The capitalisation of knowledge*

The *virtual university system* must be closely linked, both in its conception and in its implementation, to an appropriate system of capitalisation of the knowledge and information which can be considered as the baggage of the person acceding to the courses. This is part of the individual, evolving throughout his or her educational lifetime from basic to secondary education through to ongoing, lifelong learning.

As well as the explicit advantages of being in a position to capitalise knowledge in a form which is valid, even at transnational level, the ideal situation, which is effectively that which was projected by Pierre Lévy in *Gli alberi delle Conoscenze* (Authier & Lévy, 1992), must also tend to guarantee the identification of profiles of competence, in terms of quality and spendability, with a view to appropriately *orienting* the individuals accessing education so that it responds to their expectations, whether these are related to work, re-training or other.

The new technologies play a fundamental role in this context, which is that of offering a mode of information production which gives everyone the chance of being at once the author and diffuser of an expression of their own knowledge, within a system in which an increasing number of persons are aware of the fact that richness derives from the pooling of knowledge.

The risk to be avoided, however, becomes that of promoting systems, methods and structures in which the individuals are actors and protagonists in the creation of individual and collective knowledge, and not elements exploited by the economy of access.

In view of these considerations, the introduction of a system of credits which qualify and quantify the knowledge of the individual appears fundamental. Although an approach<sup>3</sup> promoted by the European Community does exist, it is currently used in a primitive condition, partly because it has consequences for the provision of the education itself, being centred on the concept of *work load*.

One of the effects which this system brings with it, and which conflicts with the current concept, is that there is a strong stimulus towards a modularisation of the teaching programmes aimed at transforming the current teaching schedules into smaller didactic-scientific units, centred on qualifying contents, which make the courses more flexible.

This approach, nevertheless, sits perfectly with the philosophy which tends towards the introduction of new educational technologies, oriented towards the creation of interactive, multimedia and hypermedia, modular and re-utilisable environments; as a result we feel that it constitutes one of the essential tools for planning and control which have to be introduced even into such a dynamic and flexible environment.

### *The technological platform*

*The characteristics, availability and continual evolution of the technological platform or of the resource tools which enable access to on-line applications on the part of the user as required in the various phases of his/her own educational itinerary, are crucial factors for the creation of a virtual university system which is centred on the user.*

At present the educational institutions use connections between the various units, workshops and departments through local networks which are in turn connected to larger metropolitan and national networks, the performance level of which (quality of service, available band etc.) is conditioned by the type of technology used.

There is by now an ever-growing number of telecommunications operators offering infrastructures and online services which are increasingly better adapted to customers' requirements. The differentiation of the public is paralleled by a extremely broad offer of technologies and services suited for all types of user: for businesses or public bodies, for utilisation in Intranet or in Internet, for the provision of services with the desired degree of interactivity, multimediality and synchrony.

---

<sup>3</sup> See Glossary and Notes – ECTS (European Credits Transfer System)



Distance learning requires that the universities make themselves available to a vast public utilising differentiated infrastructures, such as network systems and access terminals. As a result, the providers of educational services based on the new technologies must offer services which can be graduated in accordance with various parameters such as: multimediality, interactivity, synchrony, flow symmetry, characteristics of the user terminal etc.

Many virtual universities currently issue their courses on satellite channels, requiring of their users a minimal base configuration for access: a computer with a satellite decoder and a special antenna for reception. Other solutions simply combine traditional distance learning – operating through the mailing of paper materials – with systems of web-based education and audio-video telephonic conference, including many-to-many interaction.

It is clear that there does not exist a unique or ideal configuration of the technological platform for the virtual university, especially since the offer of network and terminal infrastructures evolves with extreme rapidity. Considering the multiplicity of access experiences, the technological platform should be designed and constructed in such a way as to allow for the implementation of educational training environments which can contemplate the different instrumental contexts required in the broadest way possible, such as:

- the supply of lessons with a high multimedia content (video, audio), with the possibility of interaction;
- the supply of contents via Web and Web-CD;
- interaction through interactive Web systems (chat, audio-video conference, IP network telephone);
- collaboration between collaborative systems CSCW<sup>4</sup> (Computer Supported Collaborative Work) in Internet or Intranet;
- systems of virtual laboratories accessible via Internet or Intranet, according to the degree of interactivity, multimediality and synchrony desired;
- interactive multimedia classrooms (also known as *telecentres*, or *tele-education centres*) connected with all the systems – reception via satellite, Internet and Intranet, to guarantee flexible access to the various multimedia systems, interactive and not, both on the university campus and in decentralised centres;
- ISP (Internet Service Provider) functions for users enrolled and/or recognised as belonging to the organisation;
- systems for the automatic identification of the presence of students in specific sites (classrooms or laboratories) for attendance certification (for example through the identification of mobile terminals assigned to them, such as appropriately equipped cell phones).

A technological platform integrating the various types of network – land, satellite and mobile – which can support all, or at least most, of the above-mentioned services or func-

---

<sup>4</sup> See Glossary and Notes

tions, not only in terms of the supply of courses but also for the creation of the relevant materials and contents, could reasonably be expected to serve all the potential users. In the simplest case the users would connect with their educational environment from home through a telephone type (Dial-up) connection, utilising the services offered by an Internet Provider Service, while accessing the more prized resources, both technical and human where these are made available to the users, directly or in a subsidiary manner.

In order to proceed to a systematic analysis of the technological platform, reference will be made separately to the two following sections into which it can usefully be divided, so as to highlight the requisites from the point of view of the end user:

- **Physical access platform:** understood as the *set of telecommunications networks infrastructures* – physical connections and the related computer resources to perform the function of information transport, and the *set of terminal instrumental resources for access* which the end user has at disposal for interaction online.
- **Logic-application platform:** understood as the *set of computer resources – hardware and software – and of informative contents* distributed throughout the various instrumental components of the network, including the user terminals. Exploiting also the information transport functions of the network, these make available the basic functions demanded by the application context, and enable the realisation and personalisation of specific online applications for the said context, in this case education.

### The physical access platform

*Outlined below is the analysis of the physical access platform, referring respectively to its fundamental aspects:*

- *telecommunication networks and access to them: describing the various types of networks which exist or are forecast for the immediate future, the potential access configurations for the end user and the services they render utilisable;*
- *stations and terminal subsystems for access: describing the various types of user terminal and the subsystems which organise and manage in an integrated manner appropriate user terminals made collectively available for the access to online services.*

#### *Telecommunication networks and access to them*

The availability of the telecommunication networks, and the possibilities and characteristics of access to them on the part of the end user, are an essential factor for the services to be provided within the context of the virtual university. Effectively these determine the possibilities and features of the communication which can instrumentally be activated through the network – in its function of information transport – for the end user, the student. The site of access is a decisive variable in this regard and one which frequently conditions the type and quality of the communication which can be admitted at an instrumental level. The principal types of access sites can be identified as follows:

- the university campus;
- the extramural centre or de-centralised university structure;
- the student's own stable work station (home, office);
- a transitory location (mobile).

In the *university campus* it is generally possible to adopt the network solutions which enable the most elevated level of instrumental quality for the communication and online interaction of the end user. In the physical and logistic context of the campus the university can effectively provide access to its own high-performance network. This is primarily true for a monocentric campus (isolated, even if in an urban area), but also holds largely for a polycentric campus in an urban area.

By *extramural centre or de-centralised university structure* we mean a structure which is physically and functionally autonomous in the local provision of the university services, meaning that the student is not required to live on the central university campus. This function has specific motivations and solutions for the support of de-centralised teaching activities which contemplate a significant use of the new didactic technologies. In this case too, the considerations are analogous to those made for the university campus where this structure or centre can be locally utilised by the students for services similar to those offered on the university campus. The elevated levels of performance required by online services may demand an adequate network connection between the extramural structure and the campus itself (or with the university network operating in the central campus).

In the *student's own stable work station* (home, office) the student can access the networks made available by various telecommunications operators for the necessary online connections with the university. In such cases there is a predominant use of fixed networks, but recourse to cellular mobile systems can also be forecast. In the latter case the level and differentiation of the technical performance (transmission speed) and of the costs involved, can significantly influence the technical and functional characteristics of the applications which can be performed online.

In the *transitory, or mobile, location* access to the network is generally enabled by cellular mobile systems. The technical features of cell-phone communication, combined with those of the portable terminal, significantly affect the technical and functional performance of the applications potentially exploitable online.

Several specific assessments of the currently most common types of terminal access in relation to location are summarised in the table below.

Bearing in mind the spatial context for access outlined above, below we elaborate our analysis by examining the different types of network which are available for our purposes, referring both to the current situation and to the evolution forecast for the near future.

In view of the current development of the telecommunications networks, one of the dominant factors of the present situation is the widespread and continuous diffusion of access to the Internet network. The interactive features of the services which it makes available, in particular those based on the Web, make the Internet network the primary telematic reference network even for the current services which can be comprised within the sphere of the virtual university.

TYPE OF CONNECTION	ADVANTAGES AND DISADVANTAGES
From home with access in dial-up (phone call)	Depending on circumstances, working at home can be relaxing and comfortable, and can enable control of learning rhythms. Many people cannot afford an appropriate access configuration, so that the university ought to provide a system of incentives or subscriptions to service providers so that all users are in a position to access the educational offers.
In the university or other educational institution	The advantages of this type of access are undoubtedly the possibility of accessing a rapid network, and the possibility of availing of services of support, tutoring and help in cases of need. On the other hand, in this case the assumption is that the university and/or educational centre is within reach, which is not the case for all users.
At work or at special company training centres	The advantages of this type of access are the possibilities of accessing just-in-time types of training, that is at the moment of need. The network connection will probably be more rapid than the domestic connection, but in the case of training in the workplace, the learning environment can be compromised by interruptions and requests for intervention.
On the move, using a portable computer and a dial-up connection	Mobile configurations tend to guarantee a broad degree of flexibility, but they involve a network access with a limited speed of reception/transmission, and consequently also of interaction.

To a large extent, to date access to Internet has been diffused through the use of the fixed telecommunication network – substantially the telephone network – which is that generally utilised by the individual users. The result is that the network performance is frequently limited, albeit utilisable for various applications even if at a low level of multimedia. This is particularly noticeable in relation to access from the individual stable location, whether home or office. Even more limiting – in terms both of costs and performance – is the current user access to Internet from mobile stations, that is through the cellular mobile networks.

The ISDN (Integrated Services Digital Network), functionally analogous to the telephone network, is available at higher costs for digital multimedia communications with enhanced services such as videophone and videoconference, as well as improved access to Internet. The other dominant factor in the current evolution of telecommunications is the radiotelephone networks; their development is primarily connected with the diffusion of mobile phone services through cell phones. These networks, and the respective terminals which are currently available, are considerably limited in terms of performance for access to Internet and of the applications which can be utilised.

Another type of network which has significance at present for application in the virtual university field is the television networks. In themselves these allow only unilateral broadcasting, albeit with a greater informative content – of an audiovisual type – in com-

parison with the types of transmissions enabled by the networks mentioned above. For some time now, this type of communication has been used for the transmission of videolections for educational purposes. In this field, the current diffusion of digital TV via satellite is of considerable relevance; digital transmission has enabled a significant increase in the number of television channels available in the same spectrum of radio-frequencies. (from 4 to 6 volts).

The possibility of using elevated radio-frequencies in satellite transmission, and the extension of the spectrum of radio-frequencies thus made available, further contributes to determine the elevated number of radio-television channels made available by digital satellite TV. The diffusion of access has also led to a reduction in the cost of the equipment required by the user for individual, paid access.

The use of digital transmission techniques is at the basis of the by now widespread diffusion of satellite links even for the development of interactive applications of an Internet type, based on an asymmetrical type of communication. In this case, for example, we would envisage in general the use of the land network for the low speed information flows originating from the user, and the use of the satellite channel, shared by a number of end users, for the information flow originating from the service provider. This type of usage appears appropriate for many of the requirements of the individual user of the services of the virtual university, particularly if the user pool is distributed over an extended territory – national, international, continental etc.

The wide and rapid evolution which is in progress in the field of telecommunications networks enables us to envisage, in the short and medium term, new possibilities for enhancing the potential network access also in terms of the services of the virtual university. These are essentially based on the following trends in development:

- a generalised increase in the transmission capacity – speed of transmission – individually available to the end user for online access, or the use of increasingly broad band network;
- the related increase in the capacities for multimedia services;
- the related and preferential increase in the speed of access to the Internet network;
- the specific increment of the capacities for multimedia service in the mobile networks, and the possibility of their rapid deployment and a rapid introduction of innovative services;
- the integration within the Internet of telephone and television broadcasting services;
- the integration and interoperability of the various networks for the purposes of integrating the related services.

Several specific prospects, illustrating that stated above, are briefly highlighted below.

Currently spreading through the fixed network, and to be widely available in the near future, is the possibility of individual user access at a significantly increased speed through the use of XDSL digital technology (the commonest form of which, ADSL, guarantees a

non-symmetrical flow, with a downstream speed of between 1.5–8 Mb/s, and an upstream of between 16–640 Kb/s) based on the re-utilisation of the normal duplex cable.

This solution is compatible with the access to average level multimedia services.

The use of optical fibre cables is notably augmenting the capacity of the networks in terms of the connection between the nodes, including the nodes for the peripheral distribution of access. This, while required to sustain the general and continual increase in the traffic between the central nodes of the network, also makes it possible to dispose of terminal connections of a greater capacity and sustainable costs, as well as to benefit from more elevated levels of performance within the university network on campus, and correspondingly in the various de-centralised extra-mural centres of the university.

At the same time, the diffusion of optical fibre cables right up to the user's terminal, so as to provide even greater transmission capacities at an individual level, appears to be a prospect which will only be achieved in the medium-long term. This is true in any case in those areas and countries where there is no possibility of the immediate re-utilisation of the infrastructures of the cable TV networks, as is the case in Italy. It should be noted that the use of such infrastructures generally appears economically compatible, at least in the initial phase, if justified by the requirements of access to television services, in an evolutionary process which introduces, and progressively valorises over time, interactivity for new types of service based on multimedia communication. It should also be observed that, in view of the costs involved, the use of this type of cable tends to be particularly concentrated in densely-populated urban areas. For this reason, and in view of the need for access to the most advanced levels of network services, the diffusion of optical fibre cables – even for individual access – within the university campus appears to be a goal well worth pursuing, and one which should be promoted through the creation of the economic conditions necessary to make adequate funds available.

The time required for the capillary deployment of optical fibre cables in the sub-networks of peripheral access – along with causes deriving from competition brought about by the liberalisation in progress in this sector in industrialised countries among the numerous operators of telecommunications networks, few of whom in general have at disposal a diffused fixed network – is among the factors which urge the promotion of alternative peripheral access through the mobile networks. While offering a more limited performance than that to be obtained through the use of optical fibres, these networks demand infrastructural intervention of a less significant nature, and can be more rapidly utilised for a capillary access. They also offer solutions which are economically more acceptable, even for less densely populated areas.

The prospect for the coming years is therefore the parallel development of the so-called Wireless Subscriber Loop sub-networks, that is sub-networks within the fixed network replacing the connections which currently use the duplex cable, creating a wireless connection between a radio terminal station at the user's premises (normally shared by a number of users) and a station connected to a central node of the wired network (connecting a number of radio terminal stations). Within this context of networks we must also include the LMDS (Local Multipoint Distribution System), which has a distance range of about 3.5 kilometres and a speed of bi-lateral transmission of up to 34–38 Mb/s, and

the MMDS (Multi-channel Multi-point Distribution System), with a range of about 50 kilometres, aimed at serving areas of lower population density.

Considerations of this kind, along with the emergence of a vast pool of mobile phone users, have stimulated the development – and the prospect of diffusion in the medium term – of mobile phone networks with enhanced transmission potential. In the short term the spread of the GPRS technique is envisaged, as a functional integration of the GSM mobile networks. In this way cell-phone services will be integrated with data transmission capacities for access to Internet, featuring performance and costs similar to those of normal access from the fixed network. In the medium term the diffusion of the mobile networks of the third generation is also envisaged, that is the UMTS networks with an enhanced transmission capacity, normally of around 340 Kb/s, and compatible with voice, data and video multimedia services.

These mobile networks also promise a certain utility in terms of the increased diffusion of flexible access, with qualified performance, to the services of the virtual university. Here we are not only referring to the use of compact terminals, as characteristically designed for maximum portability where the user is on the move, but also to access to these networks through fixed terminals, or the classic portable personal computers which feature a greater usability for the applications which are of interest in this context.

In the medium term, what is also envisaged is the parallel development of the diffusion of land digital TV networks. These will make available services analogous to those described for satellite digital TV, resulting in a further increase in the number of digital television channels available for each individual user, and a general reduction of the costs of the users' terminal equipment. The possibility of re-utilisation of frequencies in different areas will result in a considerable increase in the channels available for local use. This will be particularly favourable in terms of the university's opportunity to use the relative services on its own campus and in the connected residential premises, even the homes of individual students, especially in the nearby urban areas, and eventually also in the de-centralised centres.

#### *Stations and terminal subsystems for access*

Terminal access to the network is realised through the instrumental station connected to the network, through which the interaction and the utilisation of the services on the part of the student takes place.

Distinctions are made between:

- individual terminal stations
- terminal subsystems

The typical *individual terminal* station, that is for shared or exclusive (personal station) use, is at present the personal computer as it is commonly understood. Access to such a terminal for all students clearly appears to be an objective to be pursued in the short term, and one for which there is already strong motivation in the current demands of the student's activity. The same can be said for access to Internet from home or office, in terms

both of the usefulness of the services which the university will, in the normal course of events, be rendering increasingly available to the student via the web, and of those which can generally be independently enjoyed through Internet for the integration or back-up of studies or for other interests.

The type of the terminal station, and of access to the network, influences the level of performance and the capacity to exploit the various online services.

In relation to the evolution which is envisaged for the telecommunication networks, we can expect a parallel evolution of the terminal stations for online access.

As regards the personal computer, as well as the capacities for processing and multi-media interaction – which are in fact already largely available – there could be a systematic inclusion of compatibility for access to the different types of network. For access to the fixed networks, in the short-medium term more efficient terminal stations will be available for the integration of the services of the different networks. This integration will also concern the convergence of the television and the PC, even in terms of simultaneous access to digital television and other networks. The same can be said for the integration of the various communication services on the Internet network (particularly for voice and data). This evolution could also prove effective in facilitating and diffusing access to interactive services.

As regards access to digital television networks, there is a significant current trend towards making available, at the level of the terminal equipment of the end user, a consistent local memory for the continual or programmed registration of the contents of the digital information flow continually transmitted via satellite and received by the terminal of the end user. This is backed up by software tools for the intelligent and flexible management of such data in the phases of both registration and use. In this context it is important to mention the current diffusion on the market of a specific terminal instrument called a Personal Video Recorder (PVR) with a recording capacity equivalent to 60 hours of TV broadcasting, and with capacities for the intelligent management of such data in the terms outlined above. This type of instrument offers a degree of operability and flexibility for the personalisation and facility of access which appears to be of particular interest for application in the sphere of teaching.

Other evolutions relate to portable work stations featuring different degrees of compactness and usability, in relation to the diffusion of third generation mobile networks (UMTS).

For all the types of access configuration mentioned above, and therefore also for the respective terminals, special consideration should be given to the question of access for the handicapped. There exists both hardware and software which to some extent meets the requirements of this category, especially for handicaps of a sensory and/or motorial nature. A virtual university system designed for individuals cannot fail to attempt to meet the requirements deriving from the special needs of the handicapped, and not merely in terms of access in a strict sense, but also in terms of the requirements which influence the design of the educational courses, materials and products. It is therefore necessary that the technical platform should support a broad variability of technical-application solutions so as better to respond to the requirements of the greatest possible variety of users.



As well as individual and personal terminal stations, what must also be considered within the university context are the *terminal subsystems*. This latter term refers to particularly well-equipped environments for joint and shared use by a number of students, providing access to online and multimedia services for different and specific purposes.

Here we are referring, for example, to multimedia classrooms, staffed and not, with a number of multimedia stations connected on the local network, and which can include special stations not normally available at personal level. These classrooms may feature the high-performance online access required by certain applications which the user does not personally dispose of. Such structures are typically available on campus, or in decentralised university centres – also known as telecentres – or in multi-functional educational centres – also known as tele-education centres. These centres can respond to specific requirements of access to the services of the virtual university - either on campus or in decentralised centres – such as:

- access to services which demand technical and functional requisites which the student's personal terminal station or his/her independent type of online access cannot provide;
- access to training for the acquisition of personal skills for the use of terminal stations and the relevant applications;
- access to learning activities which require the collective presence of students and specific equipment;
- services of assistance for the utilisation of personalised teaching aids or those with specific contents.

On the basis of the foregoing analysis, with reference both to the networks and to the user scenario described in the preceding section, Fig. 4 shows an overall schematic diagram blocking out the variability field of the modes of access. The image shows blocks of variability relating respectively to *user types*, *space-time limitations*, possible *access locations*, and the respective *access terminals*. The blocks can be interconnected to illustrate a possible access route. As a specific, but significant, example this figure illustrates the route relating to a full-time, extramural, handicapped user who utilises special staffed educational centres, as well as access terminals which must also be specially designed to meet the requirements of the individual.

### **The logical-applicative platform**

*The logical-applicative platform is analysed in the following paragraphs in reference to its main components:*

- *the basic logical platform; which involves the overall basic functions available in a telematic network as a backup to the various applicative contexts*
- *the applicative platform; intended as a group of resources and functions for processing data, as well as services that allow for the organization and management of the specific appli-*

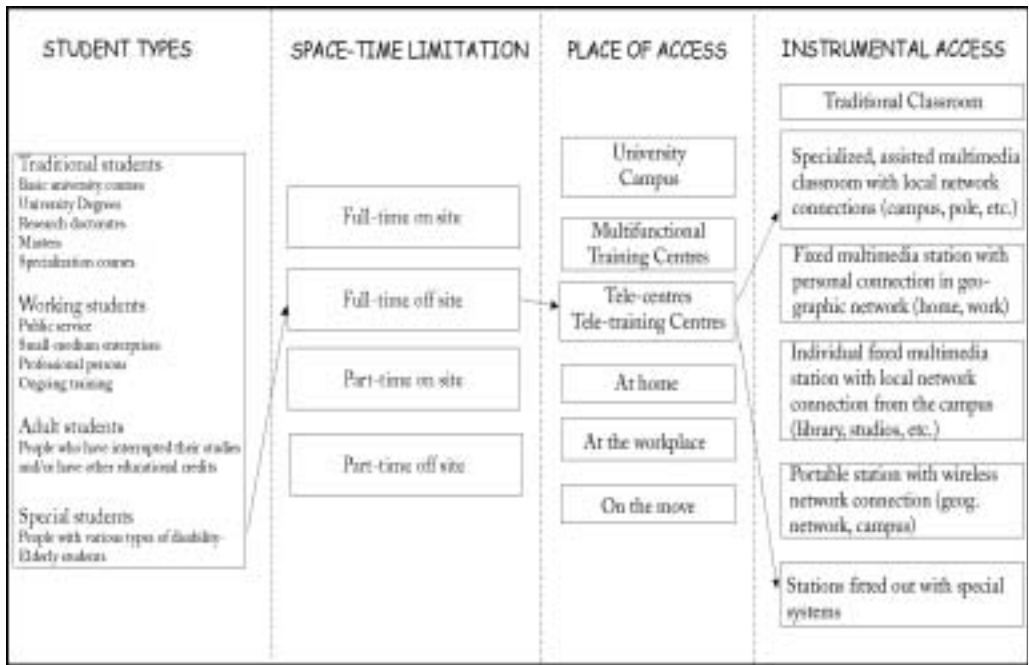

Fig. 4. Use and access typologies

*ations. The applicative platform includes amongst other things, the following environments which play a relevant role in the case of education, and which will be analysed further on:*

- *pedagogical environments;*
- *authoring systems;*
- *intelligent tutoring systems;*
- *virtual or remote controlled laboratories.*

*The basic logical platform*

The basic logical platform is intended as the group of basic functions usually made available by a telematic network, offering a common support for various applicative contexts and specific applications, and a support for the interoperability between the terminals for interaction purposes between the users of the network – regardless of whether final users or providers.

In this respect, a primary reference platform, even for teaching applications, consists of the basic services of the Internet, like e-mail, World Wide Web, chat, newsgroups, etc.

The integration of the multimedia communication services of Internet and new solutions for the safety of the accesses and the identification of the user are among the present evolutions that allow for enriching and intensifying the functionality of the *basic logical platform*<sup>5</sup>.

<sup>5</sup> See Glossary & Notes on the topic of integration on IP services online

### *The applicative platform*

The applicative platform manages the functions of the processing of the access data and services that allow for the creation, management and organization of services supplied by the Web. In the case of education, these include pedagogical environments like those of Web Based Training, Computer Based Training, and Computer Supported Collaborative Work, etc. All these applicative environments serve the purpose of integrating multimedia information, backed up by the basic computer resources.

It must be pointed out once again that the combining of the solutions offered by the telematic and multimedia technologies<sup>6</sup> could just be a winning solution in creating a virtual system for satisfying all expectations. However, it could also turn out to be an unproductive investment of various types of resources, in other words, it may not give rise to a significant improvement in education in terms of quality and opportunities if its development is not based on a systemic approach.

As already observed, from the point of view of virtual educational systems, the development of applications for managing hypermedia documents is of vital importance. Currently, the most important instrument that allows for surfing through hypermedia documents is the World Wide Web which has become the space for encyclopaedic information *par excellence*, and the platform via which plans are underway for supplying all types of services for the public, like education for example. The HTML<sup>7</sup> language (HyperText Mark-up Language) is the one used for the publication of hypermedia documents on the Web.

There are a myriad of reasons behind the success of the World Wide Web, and many interesting documents have been written to this effect (Berners-Lee, 1999), however we would like to highlight two or three particular reasons. The first is the fact that the HTML language may be created and processed by a wide variety of instruments, finally providing the suitable platform for whoever becomes simultaneously *author and consumer* of the information created. The second is that the Web system has been designed and created in the aim of allowing people to work together, thus becoming a *social creation*, as well as a *technical instrument* (Berners-Lee, 1999).

Just like many others, we are convinced that this extremely potent social instrument and sharing of knowledge that has contributed towards motivating the revolutions in progress even in the field of education, must continue its evolution in order to be able to meet the needs of the people. The creator of the Web himself, Tim Berners-Lee, discusses the ultimate destiny of World Wide Web in his latest book. Following is an excerpt from this book:

“I have a dream for the Web... and it has two parts. In the first part, the Web becomes a much more powerful means for collaboration between people. I have always imagined the information space as something to which everyone has immediate and intuitive access, and not just to browse, but to create. [...] In the second

---

<sup>6</sup> See Glossary & Notes on the topic of Multimediality

<sup>7</sup> See Glossary & Notes

part of the dream, collaborations extend to computers. Machines become capable of analysing all the data on the Web – the contents, links, and transactions between people and computers. A “Semantic Web”, which should make this possible, has yet to emerge, but when it does, the day-to-day mechanisms of trade, bureaucracy, and our daily lives will be handled by machines talking to machines, leaving humans to provide the inspiration and intuition” (Chapter 12, *Mind to Mind*, pages 157-158) (Berners-Lee, 1999).

According to this author the present revolution of the technologies may on one hand support the realisation of these dreams, while representing a threat on the other. In his opinion everything depends on the will of the people.

On speaking about advantages and threats Berners-Lee also refers to the XML<sup>8</sup> language, (eXtensible Markup Language) which is the evolution of HTML and is still at the basis of numerous applications developed for the Web. According to Berners-Lee, the XML language allows for great freedom of creation on one hand, while on the other it could in extreme cases give rise to the risk of the creation of various types of documents that are not understandable by everyone: the contrary therefore, of the long-hoped-for interoperability.

### *Pedagogical Environments*

Even though the challenge facing education in the near future will still remain the same, that is, to educate real people and stimulate learning, the new medias will provide increasingly more interesting opportunities for improving education in the sense that has been illustrated above.

The possibility of creating open and personalized learning environments is also changing the roles of the agents involved: the teachers are also becoming designers of learning experiences and the students are becoming active builders of their own learning process and itinerary. Both these groups of agents must be able to interact in a learning environment centred around the student, that must be capable of supporting the flexible and organized access to learning resources structured around different educational methods. Apart from being able to produce educational contents and activities, the educators must also be able to provide the necessary support required by the students, promote interaction, provide explanations and demonstrations, practical cases, feedback, challenges and encouragement, in the aim of promoting the student’s active participation process. For this reason pedagogical environments are necessary that support all the phases of delivering the educational contents and activities.

The Hypermedia Learning Environments (HMLE) are considered as environments with a great potential for the promotion of learning that is accessible to everyone, and for acquiring specific skills like self-regulation, cognitive flexibility, and the capacity to solve problems and manage differentiated resources. The present implementation approaches place great stress on the fact that it is necessary to pass from a systematic introduction of

---

<sup>8</sup> See Glossary & Notes

well structured contents to the organization of access, to enormous and very complex multimedia information systems, distributed all over the network. The hypermedia environments are considered as valuable in supporting adequate mental representations of complex contents by using multiple perspectives and symbol systems (Jacobson & Spiro, 1994). These same environments increase cognitive flexibility and the transferral of learning, allowing for cross-relations between topics, as well as autonomous and self-governed learning thanks to flexible access to contents that adapt themselves to the users' interests and also increase the resource management expertise thanks to the interactive support of flexible access to on-line and off-line information.

If on one hand these are the benefits expected from the creating of a hypermedia learning environment, on the other the results of experience also indicate that this type of learning may generate surfing disorientation, and as a result, conceptual confusion, thus turning out to be even less effective than traditional learning. The potential of this type of learning is yet again vast and varied, and its efficacy depends strictly on the activities planned in relation to the people the education is targeting.

One significant aspect that concerns the creation of pedagogical environments for meeting the needs of the students, involves the creation and management of *user profiles*. It is necessary to keep in mind in fact, that the efforts made up until now on a telematic application level in general, and educational in particular, have not had any marked success in their intent to guarantee efficacious profiling of the users – who are the main agents in the pedagogical environment based on the new technologies.

In particular, the standardization aspect of the student model currently aims at understanding elements like the level of consciousness, skills and expertise, learning styles and personal information in a general sense.

In our opinion the winning idea is that of being able to represent these elements at multiple levels of graininess and refinement, in order to permit differing views of the model – from the point of view of the student, the teacher, the school, the employer, etc. – for the purpose, which is anything but secondary, of complying with the requirements of privacy and security (Giuli, 2001a).

Amongst the benefits linked to the introduction of a similar model, the following points are without doubt relevant:

- to allow students of any level, age, background, and school/job, to create a personal profile based on an internationally recognized standard that can be used throughout their entire educational and working careers;
- to allow the developers of educational courses and programs to develop material that will supply a more personalized and efficacious education;
- to provide researchers in this sector with a collection of increasingly more important data;
- to provide the basis for the development of additional educational standards that are increasingly more efficacious and user-orientated;
- to supply an architectural guide for the designers of educational environments.

One of the most frequently used approaches for defining the opportune user models makes use of the strategies of metadata<sup>9</sup>, of which the Web language of the near future, XML, is the most appropriate solution.

### *Authoring systems*

The authoring systems play a vital role in the aspects of creating opportune pedagogical environments structured in various ways as illustrated in the following paragraph.

The concept at the basis of the authoring systems is the one that supplies advanced applications to authors who wish to create documents, contents or any other type of activity whatsoever using the new technologies, without having to have any knowledge of the basic programming languages. For example, Hypermedia Authoring Systems are systems that allow for creating hypermedia documents without any knowledge of the programming syntax of the HTML language or the scripting languages typical of the Web technology. Despite being quite simple in principle, these may turn out to be very complex in the event of having to create specific applications like a questionnaire with multiple answers and automatic correction for example. As a rule the hypermedia authoring systems for the creation of Web based educational environments offer the following classes of functions:

- access services for data recovery;
- communication and collaboration services;
- management services;
- authoring services.

Numerous systems exist for the creation of interactive educational environments on the Web, Web Based Training environments, and for training applications to be exploited without on-line access – Computer Based Training. Once again any attempt at reviewing these only has a temporary validity due to the evolution of the products available (Pettenati, 1999b). We are convinced that the knowledge of the attributions and characteristics of the authoring systems available should form part of the heritage of knowledge developed and offered to the university by the support centres for the new technologies dedicated to these and other functions.

### *Intelligent tutoring systems*

A very important application in the educational environment is the one for developing opportune Intelligent Tutoring Systems which help students in their learning tasks. From an educational point of view the advantage of these systems is that they are able to simulate the human relations in doing something that other people know how to do. The enormous boost in the use of intelligent tutoring systems derives from the consideration that these technologies can be activated by the students, for being used as a means of rep-

---

<sup>9</sup> See Glossary & Notes

resenting and expressing their knowledge, in other words, they become cognitive tools. For this purpose the required adaptation and learning skills that these systems have to support are of vital importance for being able to better adapt to the characteristics of the users and in this way provide support, encouragement, guidance and assistance. Evidently the problem of implementing the intelligent tutoring systems comes up against considerable difficulties as these call for sophisticated skills, like the understanding of intentionality and the possibility of inferring the consequences of an action. The fundamental requirements are *half-knowledge*, in other words knowledge of the knowledge on which one is working, *commonsense reasoning* for inferring in an appropriate manner the will of the user, the capacity to interpret the *intention* that is hidden behind a request, and the consequences of any possible actions.

It has been pointed out how, from a educational point of view, the application of the intelligent tutoring systems can find ample space in the three main areas following (Baylor, 1999):

- *management of the informative load*, via the selection and management of the information and activities, and their representation in formats that are potentially multiple and adaptable to individual situations;
- *servng as a pedagogical expert*, for monitoring and assessing the need for interventions like assistance, or the examination and adapting of these to the evolution of the student him/herself;
- *creation of programming for the user*, in which the user him/herself contributes towards the building of the tutoring system's intelligence.

#### *Virtual or remote-controlled laboratories*

The on-line teaching applications take on a specific value in the environment of the virtual or remote controlled on-line laboratories. They take on a specific connotation for teaching in the scientific and technological disciplines. Thanks to simulation. the virtual laboratories reproduce the mathematically modelisable 'real' processes which are consequently observable by means of the on-line presentations, in relation to the different dynamic configurations of the specific laboratory experience which is the object of the educational activity. The remote-controlled laboratories are real laboratories that are automated and remote-controlled via the Web, even by users interacting for teaching experiences and purposes.

### **Information and knowledge: resources and people**

*The organization of systems, methods and technologies in order for these to be centred round the user is not sufficient for supplying the virtual university system. Nor is it sufficient for supplying the skills or requirements for satisfying the users who gain access to them for building their own personalized training on the basis of their own contingent or settled needs. The factors which provide the system with efficacy, value and accessibility are information and knowledge; in other words, the contents and the people – both singly and collectively.*

Following, we have attempted to illustrate the aspects of management and processing of the informative resources that make up a part of the virtual university capital, as well as the aspect of the training and employment of human resources that represent the engine of the education system.

As already observed previously, the capital of the virtual university earmarked for being organized, developed and transferred, also with the aid of new information and communications technologies, is that of knowledge. As much as the Web, its technologies and its systems are capable of offering potentially infinite resources, the people are the ones who represent the true depositories of this capital, that must be trained, managed, enriched and optimised in order to ensure an efficacious transferral of the knowledge. The word knowledge, is usually intended as experience, concepts, values, opinions and ways of working that can be shared, communicated and transferred.

### **Knowledge management**

The science of *knowledge management*<sup>10</sup>, that becomes even more important in corporate sectors, takes care of following the processes of creation, backup, application, sharing, transferral and regeneration of the knowledge in order to increase the efficacy of the overall organization and create added value. It can be observed how this new science, together with the theories and experiences developed in the same, can also be applied for the defining of an appropriate virtual university system. In this way resources, experiences, knowledge, instruments, technologies, and systems will all find another way to efficaciously implement the processes of transferral, development and growth of knowledge.

Methodologies and solutions of the science of knowledge management can be employed validly and in a personalized manner in the organizations which operate for supplying education, seeing that they are an efficacious backup for the use of new teaching technologies. In the case of the university, this means that the new knowledge management methods must adapt themselves to the requirements of the relative transferral, while keeping in mind just what the primary sources of the university are: *scientific research*, and *teaching experience*, with the relative products that become the qualification elements of the university and in particular, of the relative human resources.

Therefore the *management of the university research* and its products also takes on a specific relevance for the needs of the virtual university, as required for the qualification of the educational activity. This relevance grows hand in hand with the progress of the course of the university studies, while in the initial phases of this course it is the valorisation of the *teaching experiences* and their connected skills that play a more determining role.

### **The skills of the virtual university**

The advent of this new complex of communications and information environments for learning and research is without a shadow of doubt, bringing to light the need for new professional roles capable of promoting an efficacious and knowledgeable use of telem-

---

<sup>10</sup> See Glossary & Notes



atic resources. Changes will certainly take place in both educational planning and delivery approaches by means of the new technologies. According to Philippa Lévy<sup>11</sup> from the Department of Information Study of the Sheffield University, the support for higher education students in a Web environment calls for a context of careful and wide-scale development of specific skills. This writer has adopted the term Networked Learner Support (NLS), for indicating the complexity of support functions for the student who learns via the Web, and which implicate an approach to assistance and reference operating within a telematic environment. Evidently the new combination of knowledge and expertise necessary for satisfying an efficacious support for the students must include the aspects relating to the information technologies and the knowledge regarding pedagogical use of the new technologies. The use of the new technologies leads us to consider the educational services as the result of *interdisciplinary cooperation*. The success of the system depends to a lesser extent on the technologies, and to a greater extent on the creativity, inventiveness and initiative that the people apply in creating education environments.

At the present time, despite the fact that efforts are being made in this direction, no appropriate training courses are institutionally available that are capable of promoting specific skills for supporting the new technologies in education. However, what is even more limiting is the fact that the perception of the need for specific structures for supporting this new type of training is still very underdeveloped in this country.

According to studies and interviews in the sector of educational technologies, the skills required in this sector can be grouped into four categories:

- *Information Technology Expertise*, to allow for the development of educational material;
- *Information Expertise*, for the use and evaluation of telematic informative resources;
- *Educational skills in telematic training environments*, for the support of open learning, communication, educational planning, tutoring, etc;
- *Team-work and Change-management*, which refer to the skills, inclinations and attitudes necessary for working in an interdisciplinary sector.

The skills and professional expertise required in an educational environment like the virtual university, indicate that the various functions must be shared between groups which have complementary competencies and knowledge and cross the borders of the sciences of education, telecommunications, informatics, psychology, artificial intelligence, communication, library economy, and many others. Putting together all or many of these skills for new functions, essentially raises the issue of redefining and reorganizing the current approach to teaching, learning and research, via collaborative work relations in a new, and hopefully flexible, educational space. It is therefore clear that roles of this type will change, also in response to the typology of the user, in order to guarantee that the introduction of increasingly more innovative technologies takes place in a new and efficacious support for teachers and students.

---

<sup>11</sup> <http://netways.shef.ac.uk/about/staff/phil96.htm>

It can be argued yet again that aspect of ongoing education of new specific professional skills must be observed from an institutional point of view and centralized to serve the university system.

The realization of educational courses that use the new technologies does not just concern the teachers. It is therefore a good idea for the support centres for the new technologies to provide appropriate education for people with different profiles and training, who hold typical already-existing positions like the following:

- *Administrative staff*
- *Librarians*
- *Teachers*
- *System theory technicians*
- *Media designers*

or new positions of capital importance for the success of the initiative in integrating the technologies into the education, like:

- *experts in educational technologies, or education designers*, those in charge of designing the education interventions using the new technologies;
- *tutors*, those who follow the students during their education, also through the Web, acting as instructors, guides, interaction promoters, etc.;
- *evaluators/monitors*, the people who supervise and assess the education project, both during its creation and its delivery;
- *experts in man-machine usability/interfacing* the people who contribute towards the creation of educational environments that use new technologies, dealing with the aspects of usability and interaction, also with a particular eye towards the specific needs of the special users.

It is evident that other positions and skills exist that may turn out to be vitally important in the virtual university system as illustrated up to this point. We are talking here about the emergence of new intermediary positions required for guaranteeing the overall functioning of the system. In fact, it is important to observe how while on one hand the new technologies have had as their general effect the *de-intermediation* of certain figures which were previously considered as important, like the broker for economic transactions, the editor for publishing, etc., on the other they have induced the need for *new intermediation figures* which are dynamic, meaning subject to evolution over the years. In the case of educational systems – and not only – several figures of this type which have already had a certain value on the labour market are the following:

- *The Web surfers*, people who surf through the information and know the fastest and most efficient research strategies and methods for providing a rapid and punctual answer to a precise request. Just think of the importance of this function as a backup for virtual students: like a sort of librarian of

the encyclopaedia of knowledge who catalogues the information and knows exactly on which *shelf* of the immense library not only the desired resource is found, but also a myriad of other pertinent and potentially valuable information.

- *The guides*, figures who, as already mentioned above, have the task of guiding people through their training course, also in relation to the current labour offer on the market, and on the basis of this information they also know how to address the planning and design of the new educational offer, in order for it to be more in line with the needs of the people. The guide has the important role of knowing how to determine the needs of the people and as a result, guide them in the personalization of their own training courses.
- *The pedagogists of the new technologies and experts of contents*, these are the ones who should flank the trainers in order to teach them how to teach a certain specific subject, also via the use of the new technologies. Already in many American campuses teachers of a specific discipline, like physics for example, are employed to teach the other teachers the best way to teach this subject. It must be noted that this function is extremely complex since it simultaneously calls for both the capacity to adapt to the innovation, typical of youth, and a certain framework of experience, which is typical of the more seasoned teachers. This would involve a means of appraising people with many years of scientific and teaching experience who nevertheless, in this new context, would have trouble in adapting to the use of the new technologies, here again via the intermediation towards the new technologies, in other words, operated by younger teachers with technological skills.

Having identified these expertises, it is extremely interesting to watch how the labour market is beginning to adapt itself to the need to supply the corresponding skills (Pettenati, 1999b). In the United States in fact, there is already a strong demand for experts who are highly qualified in Educational Technologies, the profile of which has to include pedagogical and technological expertises, as well as other specialized skills in this environment.

Before closing this paragraph, it is necessary to note another important aspect involved in the training of the teaching staff. The latter are called on to invest time and resources in order to be able in some way to master the new technologies and integrate them into their teaching.

Seeing that the *teachers* are the main promoters of any innovative education activity, it is of vital importance to facilitate their efforts in this direction. Until such time as the basic education becomes natural for teachers and they gain experience in using the new technologies, or until a new rational approach for their training has been developed and accepted, the use of the new technologies for teaching purposes runs the risk of remaining an isolated, personal and occasional choice.

Even though in Europe part of the delay can be blamed on the level of computer and telematic literacy which is still much lower than in the more advanced nations, the present situation does however indicate that the use of telematics in education is coming up against obstacles everywhere. The reasons for this situation are many and varied. On meeting and talking to experts in this environment, it has come to light that several of the reasons preventing the explosion of the use of technologies in education can be grouped into two motivation classes, the first of which is linked to the habits of the teachers themselves while the second is connected to the organization of the educational institutions:

*Factors linked to the teachers:*

- Lack of time;
- Computer anxiety;
- Lack of incentives and motivation.

*Factors linked to the institutions:*

- Lack of awareness of the potential benefits of the new technologies in education;
- The need to redefine the new standards of teachers, with new knowledge and expertise, adequate salaries, etc;
- Lack of opportunities for ongoing education and constant refresher courses;
- Lack of continuative and institutionalised support.

As already mentioned earlier on, the aspect of suitable salaries in the case of the teaching body orientated towards the use of the new technologies is not in fact a secondary factor with regard to the success of the initiative. Whoever has ventured, even if not with virtual classes but with simple interactive applications, into the production of multimedia material, forums or anything else in this environment, is well aware of just how much work, time, creativity and effort is involved. At this stage, if the institutions of the virtual universities fail to develop appropriate policies and supports for being able to guarantee an equitable distribution of the work load, appropriate verifications, and quality, cost and investment turnover controls, there is very little hope of this enterprise being able to lead towards a real, efficacious and efficient service for all the types of users.

The natural consequence is that diversified teacher roles are defined which have to contemplate the integration of old and new skills and experiences, with the former being valorised – yet again – by opportune intermediation mechanisms.

By way of an example the natural evolution of the role of another important profession is mentioned here, the *librarian*, a role that must evolve in a coherent manner hand in hand with the role of the teachers. Librarian work has been identified as a specifically qualified skill for assuming a relevant role in the planning, distribution and support of the distance or hybrid educational activity. The librarians of the virtual university will obviously still maintain their present roles for support services, as well as for services of reference and documentary research, librarian literacy, the management of inter-librarian loans, and

the distribution of documents, etc. However, what is even more important within the context of the virtual university, is the special task of understanding the needs of the final users in order to create services and provide valid support in the offer of personalized access to information, in other words, the educational contents for students who use the new technologies in their training itineraries.

### **The Web-based electronic educational contents**

*The Web-based electronic educational contents represent the enormous capital of information and knowledge that is available for the teaching objectives of the student via the telematic network. These are a fundamental part of the capital to be managed and optimised in the virtual university. In this regard the libraries take on great importance in the sense that is hoped for them, in other words, as organizers of the accesses, resources and methods that they use for achieving this goal.*

#### *The digital libraries*

The libraries will certainly carry out a fundamental role in the virtual university model. It has been pointed out previously how libraries can only survive the revolution of the new technologies if they adapt and change their role as *suppliers and custodians of knowledge*, to become *organizers of knowledge, accesses and resources* (Pettenati, 1996). This approach is in line with the changes that are required in all the academic activities and the roles played by their agents. Libraries and librarians must employ their resources increasingly more in the acquisition and organization of the access to the documents and contents researched in answer to specific, precise and punctual requests from the individuals.

Under the pressure of the growing rate of the use of the new technologies in education, libraries and librarians will be obliged to extend their roles, be it in a somewhat a temporary manner, to the level of electronic editors. At present, the new technologies supply all the necessary facilitations – technologies, instruments and methods – for allowing the educational organizations, universities and scientific libraries, to become electronic editors. The need for this enlargement of functions derives precisely from the need to extend available literature and make it readily accessible in a personalized manner for remote users.

Libraries always train their staff to assist readers in an efficacious manner, however more recently the new technologies are supplying instruments and methods which allow librarians to respond with even greater efficacy and timeliness to the requests of the individual students.

Without running the risk of exaggerating, it can be stated that the library world is amongst those fields which are moving more rapidly than others in the education environment, towards a stable and efficacious policy of assistance for remote users and the personalization of services. This latter aspect is the most important in the future organization of the virtual university as a system of organization and personalized access to information and knowledge. The organization of an appropriate system of access for the final user has its roots in the possibility of developing adequate services for the user, in order to allow the access, management and processing of the informative contents, starting from specific personal requirements.

These services can be classified as follows:

- *Research services*, like the traditional ones in library catalogues, and the ever-increasing number of research engines on the Web, which allow for an increasingly higher level of refinement in the research interrogations.
- *Systems of access*, and recovery of information; which allow for gaining access to the documents themselves, the most widely used up till now being the World Wide Web.
- *Systems of management and display*, for the processing of information and allowing for the transportability of the documents, the management of the various media forms, and the research of the contents of the documents.
- *Personalization systems*, these are without doubt the fundamental services that aim at supplying instruments and methods allowing the on-line student to gain access to, and integrate with, the system of information and contents in the manner that most successfully meets his/her individual needs. As already pointed out in the previous paragraphs, the definition of the user profile is a crucial point in this regard.

#### *The standardization of the educational contents*

The creation of a virtual university in which the training courses are created and personalized according to the educational requirements of the individuals, has its efficacy based on the criterion of *interoperability*. A method must be defined for supporting the sharing and reuse of pedagogical modules and elements for the composition of courses, curricula and programs. Several international committees have been set up to define the standards possible for guaranteeing the interoperability of the training systems, amongst which there is the high profile LTSC<sup>12</sup> – Learning Technology Standards Committee, of the IEEE.

This committee proposes, amongst other things, the following significant objectives that in our opinion are of a general nature and value:

- To allow students and teachers to gain access to, recover, assess and use the pedagogical objects;
- To allow for the exchange of pedagogical elements between different training environments;
- To allow for the development of the pedagogical objects via the use of elementary units that can be decomposed and recomposed in different ways;
- To allow the intelligent tutoring systems to automatically and dynamically compose personalized lessons;
- To allow for the recognition of the education acquired by means of a pedagogical element;
- To develop a market context of pedagogical elements;

---

<sup>12</sup> <http://grouper.ieee.org/p1484>, <http://standards.ieee.org>

- To provide a standard that allows for the reuse of information in relation to the efficacy of the use of the pedagogical objects;
- To define a simple and extendible standard that can be used in different educational contexts;
- To integrate the notions of security and authentication necessary for the distribution and use of the pedagogical elements.

### CONNECTION, COOPERATION AND COMPETITION

*The development of the virtual university system within a university must be carried out in relation to the aspects that are able to highlight the “connection” and “cooperation” of the different systems operating in the very same context, like the aspects which imply mutual “competition” between these systems. Aspects of connection emerge in the relationship between the virtual university and educational actions that in the same university are designed to favour the adequate integration of the university students into the Information Society. Internal connection aspects also involve two quite different, though contextual modes of virtual university action, that imply on one hand the possibility of a “maximum de-territorialisation” of the university campus, and on the other, its “new territorialisation”. Lastly, reasons for cooperation and competition may emerge and must be balanced one to the other within the environment of interuniversity cooperation, in the aim of supplying the services of the virtual university.*

#### **University students of the Information Society**

The university student is an important subject in the context of the Information Society. On one hand he/she becomes the specific subject inasmuch as being the consignee and exploiter of the teaching services supplied on the virtual university network. On the other hand it can be observed how the university student's period of university education may and must necessarily be considered as a determining period for his/her maturation into an aware, active and qualified individual within the Information Society.

It cannot be denied that the high growth of the individual's cultural level, in its widest sense, gained from the period of university education and aimed at active integration into the Information Society, places the individual him/herself in a more privileged position for the potential advantages deriving from his/her own insertion in network society and economy itself. In other words, for his/her insertion into an on-line society and economy that are in continuous, parallel growth according to the mechanisms and pervasive conditioning of the globalisation process backed up by the system of relations and interactions on the Web. This Web context in fact brings about the valorisation of the culture as a dominant factor from the point of view of the connected economic development, and also as a privileged opportunity for those who are holders of culture at higher levels.

The present-day rapid and widespread development of the Information Society imposes that during the university education period the University itself takes increasingly greater steps to ensure that the conditions allow students who finish their studies to take the greatest advantage of these insertion opportunities, thus becoming direct and aware interpreters and agents of the Information Society and its evolution.

This means that the university has to contextually provide the structural and organizational interventions necessary for guaranteeing not only that the students acquire a general practical and theoretic knowledge allowing them to be able to have the use of and master the Web services in the diverse applicative sectors of the Information Society, but also adequate knowledge and skills of interpretation and action pertaining to the relative evolutionary processes. Moreover, the university itself must support the students in acquiring the skill to transfer their own knowledge and to interact on-line in the new and different manners made instrumentally possible, that are more appropriate and professional for the requirements of their own activities in the sector of specific expertise followed during their own particular study course .

These prerequisites mean that the university must structure its own students as a whole, like an on-line community, in which each student may have instrumental access to various typologies of on-line resources and services. This pertains not only to access to services made directly or indirectly available by the university for the more general, individual and collective needs of its own university life, but also access to the on-line services made available by the university as a vast backup to the different activities of interaction and relational of the university community – lecturers, students and other staff – for the institutional functions of teaching and research. Included amongst these services therefore are those which are active and fit into the teaching context of the Virtual University.

The synergy between the structural interventions required in order to favour the insertion of the students in the Information Society, and that of the specific teaching value required by the virtual university is particularly evident.

This synergy, together with the evident contemporary growth of their demand make both these interventions easier to support and also less open to procrastination.

In particular, this synergy derives from various factors: the technical infrastructures are on the whole shared; the human and organizational resources of the technical support of the system are on the whole shareable; the virtual university teaching supplies the students with attitudes that can be brought to fruition in future educational activities of the same nature, and later on for their insertion in jobs for the goals of professional updating and ongoing education; the methods and instruments for on-line learning used by the students in the virtual university context favour the maturation of specific skills and on-line interaction abilities for activities that require specific expertises cultivated in their own course of university studies and that can be directly exploited in their own future and corresponding job activity.

### **De-territorialisation and new territorialisation of the university campus**

The evolution towards the virtual university implies the resorting to access modalities that involve a complete *detrterritorialisation of the access*, in other words, a modality of access for the final user, without any direct rapport – in person – with other people, in which he/she would operate exclusively from his/her residential site. In actual fact this extreme modality of access is proposable and usable when there is no other more efficacious or practical alternative, for example, due to operating restrictions connected to subjective conditions of the user.



The opposite situation is the one in which there are no subjective pre-conditions of the final user that prevent him/her from taking part in person at the necessary teaching activities – as with traditional training – or from living in places that allow him/her to attend the campus on a regular basis. Moreover, in this situation the educational value that can be attributed to life in the university environment is also very important, especially at a young age, due to the direct relations that he/she forms with the other students and professors, as well as the external social life connected to campus life.

It should be pointed out also in this second case that the resorting to solutions made possible in the virtual university context may find a valid collocation according to the specific advantages involved.

One possible advantage is for example the fact that the new supports offer greater efficacy for learning targeting specific goals.

Another advantage is linked to the fact that sometimes the quality of the teaching activities requiring the presence of the student cannot be guaranteed at suitable levels like for example in the case of too high a number of students with access to the same course. In this case these can certainly be more efficaciously substituted by the resorting to instrumentally supported teaching activities from one's own home as well.

Another undeniable advantage arises from the possibility of exerting accessory activities for administrative, orientation needs etc., by means of the systems provided in the context of the virtual university.

In actual fact, the availability of an individual access from one's own home, also in the case in which the student can regularly attend the activities of the university campus in person, may lead to the reduction of his/her presence at the activities of inadequate quality with their recovery in newer and more relevant modalities compared to the direct personal interaction in the university environment. In this case a new territorialisation of the university campus is formulated in relation to the new modalities of the activities that involve the presence of the student at the campus itself.

All in all a transformation of the university is prefigured along two parallel courses, in other words with two subsystems that are synergic one to the other, and tend to absorb the new virtual university solutions differently. One tends towards the *detritorialisation of the university campus*, while the other tends towards a *new territorialisation*. The new territorialisation may be a considerable advantage, more so on a short-term basis for universities that suffer from insufficiencies and scarce logistic flexibilities, as for example may be required in new university installations or those distributed in urban contexts that present transport difficulties. The above is also valid for the university centres that are territorially decentralized.

### **Cooperation and competition between universities**

Universities may operate singly in terms of virtual universities. In this respect it is also important to examine the terms in which their *cooperation* and/or their natural *competition* can be organized for this purpose.

It can be observed primarily how the virtual university, particularly in the more detritorialising configuration of the access, grows out of proportion within its own potential

user pool. Even more so when it manages to overcome language barriers, like for example with the use of a widespread, or tendentially globalised language – typical for example, with English. This is therefore a condition that tends to amplify competition between universities, even between more territorially distant ones. And this in itself is also a factor that rewards the quality and spendability of the educational offer of the single university that at the same time tends to exclude from the context of the virtual universities any others that fail to offer or maintain adequate levels of quality and spendability. For the latter, the reorganizing of the traditional user pool must also be prefigured, seeing that it may be eroded by the growth of the virtual university users.

On the other hand, it can be observed how single universities may find useful or convenient conditions for cooperating in the aim of supplying their own educational offer within the context of the virtual university. The motivations in this regard could derive from the opportunity to reduce the respective economic expenses connected to the activation of the system for the production and supplying of their own educational offer as a virtual university, which actually turn out to be very high during the initial production phases. Otherwise they could derive from the demand for the interoperability of their own systems also in order to guarantee flexibility of integration of the training courses.

The levels and ranges of cooperation must consider and compose requirements that are capable of taking into account the maintenance of competition ambits, typically for aspects retained as distinctive and relevant in a specific manner for the single university. In this way an autonomous certification of the training courses can be expected, which together with the relative supply modalities, may turn out to be different for the single cooperating universities. Vice-versa these courses may be supplied as individual units and certified as a whole, especially for specific education goals that may obtain conditions of feasibility and greater qualification and competitiveness from the integration of the contributions from the single universities. All in all, with regard to the above considerations, there are various natural ambits for which appropriate forms of *inter-university cooperation* can be found for developing the virtual university for the needs of the single university, or for the natural ambits of distinction and maintenance of the autonomy of the single universities.

The following can also be included amongst the more natural ambits of cooperation:

- the technical standardization for the interoperability of the technological platform ;
- the standardization of the processes of education certification for the recognition and transferral of education credits;
- the shared development and use in a combined or replica form of basic infrastructural or structural components of the technological platform and the relative management facilities;
- the cooperative production of elementary pedagogical contents of a more static, less obsolete nature, and their management as a “knowledge pool” with shared access for the autonomous reuse and reprocessing by the single cooperating universities.

It seems appropriate that natural ambits of interuniversity cooperation are researched within a national university system, seeing that they are supported by public funds.

The following may be included among the most natural ambits of distinction and autonomy, even within a competitive picture:

- the autonomous production and exclusive use of the distinctive pedagogical contents for the single university, also if necessary with the introduction of added value to the elementary contents of the above-mentioned “pool of knowledge”;
- the exclusive support of the single university for the management of teaching support processes by its own staff (professors, tutors, etc.) at least for the parts of the training course the quality of which must be ensured directly by the single university.

Interuniversity cooperation does not appear in general to be very appropriate when based on the delegation of shared functions to autonomous delegates – i.e. consortiums, if this involves the supplying of a teaching offer in open competition with that of the single university.

## CONCLUSION

In this contribution we have tried to outline the overall system that the virtual university activates by means of its various structural components: the *Organization and the Rules*, the *Technological Platform*, and the resources of *Information and Knowledge*.

The central point of view of the analysis conducted derives from the assumption that the virtual university system has to be weighed up, designed, carried out and managed in order to meet the needs of an ever-increasing pool of users who gain access to university education, with increasingly more specific and individual motivations, characteristics and requirements.

The evolution towards the virtual university, passes primarily from the consolidation and spreading of the basic knowledge and specific awareness that are determining factors for its development, to the acquisition of methodological and instrumental knowledge and appropriate elements for consolidating the ability to supply the services. Moreover, knowledge and awareness are also necessary for organizing the evolutionary processes that in any case accompany the introduction of the new technologies in education, as well as appropriate dynamics, and various, parallel transformations that compete in determining the condition of efficacious supportability of the system. The new technologies of Information and Communications in fact plunge the education systems into a profoundly different, articulated, and flexible system, which can however also turn out to be chaotic, difficult to manage, and unpredictable. A fundamental goal of the university is therefore that of knowing how to find opportune systems, methods, technologies, data, and knowledge for supporting an evolution with continuous adaptation to the development

requirements of the virtual university, but also of configuring as integrated and interconnected systems, in a much wider global system, meaning that of the Information Society.

*The organization and rules* must therefore find a continuous equilibrium between methods and solutions in order to be in line with the new systems and guarantee not only the efficient and necessary support and coordination, but also to allow for the evolution of new methods for backing up the requirements of the new virtual system.

*The Technological Platform* evolves with great rapidity, offering increasingly more innovative features and availability for backing up the access by students according to the different phases of their training courses as well as to their access needs and availability.

The analysis of the user *typologies* and their *access modes* allows however for taking into consideration the elements making up the technological platform – the *telecommunications network*, the access systems, the *basic logical platform*, and the *applicative platform* – in such a way as to be able to outline an instrumental system of the virtual university capable of serving the different types of users with all their specificities, and also of promptly adapting to the ongoing technological innovations.

*Information and Knowledge*, intended as resources and people, are considered as the true capital that the virtual university is called on to manage, organize and prepare in order to make the education system available. As a result, stress has also been placed on the methods, structures and training of its staff that are suitable for meeting up to this new demand.

Another crucial aspect that has been dealt with concerns the aspects of the Connection, Cooperation and Competition of the new virtual university systems, for the purpose of shedding light on certain relevant issues, in other words the contextual need (increasingly more to the fore) of training students to become agents in the Information Society, and the effects of the deterritorialisation and new territorialisation of the campus, which is becoming an environment that allows for both flexible access from a distance according to the individual needs, and a different local exploitation of the campus and its resources for ensuring a better response to the needs of teaching and student life.

Some of the fundamental actions that are operatively tenable even in the short and medium term, and have to be kept in mind in order to pursue the goals illustrated in this chapter, are without doubt the analysis of the new, more widespread pool of feasible users and the definition of educational courses and specific and distinctive knowledge values.

Moreover, on various occasions emphasis has been made on the need to develop internal backup systems, like centres of interdisciplinary expertise, and centres of services and transversal support, also capable of supplying amongst other things, specific training of the new skills.

The need finally arises for the new requirements outlined above to enter to form a normal part of the university development strategies and programs.

## GLOSSARY, ANALYSES AND LINKS

**Intelligent tutoring systems:** the intelligent tutoring systems are systems that operate in the software environment, via the use of operating systems, databases, internet resources etc., in the aim of helping users to carry out particular tasks, in an attempt to reply to individual requirements. This type of technology combines artificial intelligence (reasoning, planning, natural language, etc.) with development techniques (programming to objects, scripting languages, man-machine interfacing, distributed processing, etc.), and their predominating characteristic is that of knowing how to manage the cooperation between distributed programs and/or other tutoring systems in order to provide the users with an intelligent assistance and a more natural iteration. It can be observed in this regard how the intelligent tutoring systems, in order to be truly efficacious, must be developed according to the metaphor of the *personal assistant*, whose fundamental characteristics are reliability and expertise. Other essential characteristics have been identified for an efficacious intelligent training system, like *empathy*, *sensitivity*, the *demonstrating of emotions*, *honesty*, and *co-operability*. These characteristics, which are typically human, must be developed by degrees, via the functions and actions of monitoring the behaviour of the user, the direct training/instruction of the intelligent tutoring system by the user, and collaboration with other analogous systems.

**Electronic libraries:** for the sake of an example, two important libraries are cited below which are efficaciously implementing the process of renewing technologies, methods and services as outlined above:

- the first is the CERN (European Organization for Nuclear Research) scientific library<sup>13</sup> in Switzerland that is organizing a vast information system in both internal and open electronic catalogues, as well as other important initiatives for meeting the needs of the users in the personalizing of information via the definition of a user profiling<sup>14</sup> system with user profiling that serves for helping researchers in the access to more specific and pertinent information by means of virtual shelves and personalized borrowing.
- The second library<sup>15</sup> is that of the University of Tilburg (Katholieke Universiteit Brabant) in Holland, which is not only organizing an efficient system of access to the information in catalogues and external and internal resources, but is also providing training and personalized assistance for the users, via on-line courses and contacts with expert tutors in different disciplinary environments. In this way users are guided to become the builders of their own access to knowledge, via the full awareness of the practical aspects and available resources<sup>16</sup>.

---

<sup>13</sup> <http://library.cern.ch/>

<sup>14</sup> <http://Weblib.cern.ch/Home/>

<sup>15</sup> <http://www.kub.nl/ext-uk/index.html>

<sup>16</sup> <http://cwis.kub.nl/~dbi/english/instruct/course.htm>

**CSCW** (Computer Supported Co-operative Work): indicates the huge ensemble of applications for the creation of new environments where cooperative group work can be supported and facilitated. A cooperative system is a combination of technologies, individuals and organizations that facilitate the communications and coordination necessary for supporting the efficient group work, where the results of the cooperative work is the product of a rational organization and a communications flow that amplifies and increases social relations and dynamics.

**ECTS** (European Credits Transfer System): in Europe the initiative of introduction of a unified system of university credits has been analysed in the European ECTS project, the aim of which is, amongst other things, that of introducing a credit system, promoting the guarantee of recognition and transparency of the programs also in order to benefit the cultural migration of the students.

On-line at: <http://www.unifi.it/unifi/statuto/crediti/indice.html>

**e-Europe**: this projects operates under the slogan of “An Information Society for All”, the aim of which is to support an adequate level of knowledge of the technologies in individuals so that they can exert their nationality in all its aspects, in an aware and efficacious manner within the Information Society.

On-line at: [http://europa.eu.int/comm/information\\_society/eeurope/index\\_en.htm](http://europa.eu.int/comm/information_society/eeurope/index_en.htm)

**Knowledge Management**: this science analyses knowledge and its relative transferral in terms of both object and process. From the point of view of the object, it studies the methods of memorizing, storing, sharing and transferring the knowledge.

From the point of view of the process, it studies the ways of facilitating the collaborative processes, the dynamics of learning and the application of expertise.

**Instructional Management System project**: a project that aims at studying the standardization of the pedagogical elements.

On-line at: <http://www.imsproject.org/>

**Integration of the IP services on-line**: the elaborative processes for the integrated transmission of the services are found at a conceptually higher level than the physical level or that of transporting data. At the present moment the different communications and telecommunications systems are based on various networking systems: networks for data of which Internet is a prime example (textual, graphical and miscellaneous data), and networks for fixed and mobile telephony. Nevertheless, the enormous spreading of the Internet network and the potential applications in all sectors of human life, including education and the systemic restructuring of the myriad of elements connected to education, promotes the creation of new systems, methods, services and technologies that are able to efficaciously support this trend. In order to meet these demands, it will be necessary to supply opportune processing resources.

The integration of the services on the IP protocols (Internet Protocol, on which the Internet network is based) is at the moment the most important example at that must be considered as significant of the current trend, and a basis for the decisions and systemic designing of a virtual university system that satisfy the demands which can be expected from the same. The current technologies and those foreseen in the near future, allow for efficaciously managing, via the use of different qualities of services and classes of services, such data as voice and video which are susceptible to delay, as well as normal data. The integration of the services on the IP protocol offers the advantage of allowing for the use of unified management systems that are standard, more scalable and less dependent on the manufacturers of network devices.

The integration of all the classes of data on the IP network also allows for using physically existing networks (like optical fibres) with the current protocols, with the result of not changing the infrastructure, but of unifying the services.

This represents considerable advantages for the education systems: complex systems that up until now aimed at supplying audio and/or video conferences (as a rule carried out on ISDN networks) and integrating them with multimedia presentations or blackboards shared by means of Internet, will now become naturally integrated services that are far easier to manage and set parameters for in terms of quality.

The future of video flow transmissions in multicast (the transmission of one to many) will become a primary resource and be used with the same ease as we now use a traditional telephone, meaning that both live and recorded lessons will be transmitted to all the students registered in the class, for being individually managed by each one on their own receiving terminals and to suit their own requirements. At the moment the multicast transmission protocol, that differs from unicast – one to one, and broadcast – one to all, and is the one that will be used in a more widespread manner for the creation of virtual classes, has still not been standardized, however it is adopted and used by an ever-growing number of ISPs (Internet Service Providers).

**Hypermedia:** the term *hypermedia* indicates a synthesis of hypertext and multimedia; from the data processing point of view, hypermedia means a network of informative nodes, with connections between these nodes. *Hyper* refers to the structure that can be crossed in a non-linear and interactive way. *Media* refers to the information contained in the nodes which can be of the textual, graphic, sonorous, and animated type, etc. The hypermedia documents use the reference structure of the hypertexts with a much richer media source.

**LTSC** (Learning Technologies Standard Committee): is a committee which studies the standardization of the pedagogical elements. It is organized into study groups with the task of proposing standards for education in the following sectors:

- *General*; concerning the reference architecture and models, and the standardization of the language used in the various work groups.

- *Student-user related*; this sector deals with the definition of appropriate student models and markers, as well as the identification of parameters for assessing the quality of the education based on the new technologies, and the definition of the types of expertise that are offered by the courses.
- *Content-related*; for the regulating of media formats, languages, and environments for managing the learning sessions in sectors that use intelligent tutoring systems and automatic tutoring systems, etc. in the aim of allowing for the adaptation of the lesson. It also takes care of defining the parameters relating to the student's progress and the composition of the contents of the courses.
- *Data and Metadata*; defines the real meta-elements and semantics, that must characterize the pedagogical objects in order to guarantee their localizing, exchange and interoperability. If necessary, pedagogical attributes (degree of interaction, requirements etc.) can also be defined for a specific pedagogical element. The metadata relative to the localization can also be defined in this sector, including cultural aspects as appropriate iconic and metaphoric signs for the interfaces and exchange protocols of the pedagogical elements.
- *Management and applicative systems*; this sector deals with the standardization of description methods of the courses, the list of contents, the sequential pattern of the lessons and the analysis methodology of the students' performance during the lesson. Moreover, it is also concerned with the standardizing of the platforms and relative medial profiles for which compatibility for specific pedagogical environments is required. Another purpose of this sector concerns the regulating of the communication between software environments and instructional agents, in relation to the actions that the students carry out with the software environment and the requests and/or replies of the educative agent (or agents).

Many of the standards developed by the LTSC, will be proposed as international standards by the ISO/IEC JTC1/SC36 – Information Technology for Learning, Education, and Training Working and Study Groups (On-line at: <http://jtc1sc36.org/>).

**Metadata:** this is data that describes other data, or more specifically contains the structured description of a piece of information. This description includes all types of information, from the textual description of a certain document to the detailed definition automatically generated by the development tool.

One result of the standardization of the metadata for the education contents has been implemented in the famous Dublin Core Metadata Agreement (On-line at: <http://purl.oclc.org/dc>).

**MIT Media Laboratory**

<http://agents.www.media.mit.edu/groups/agents/publications/>



**Rory McGreal**, TELE-EDUCATION NB

<http://teleeducation.nb.ca/>

<http://teleeducation.nb.ca/staff/roly/>

**XML** (Extensible Markup Language): XML maintains the possibility of structuring the documents via markers, just like in HTML, but with the difference that it supplies a set of extensible markers that can be created by the authors or the community of authors in relation to their needs. An XML document is also extremely simple, and as with HTML, it can be written by hand or with the aid of an appropriate editor.

On-line at: <http://www.w3.org/XML/>

### BIBLIOGRAPHY

- Abou Khaled O., Pettenati M.C., Vanoirbeek C. & Giuli D. (1999), *Critical Issues to Choose a Web Based Training Authoring Systems*. In the 10<sup>th</sup> EAEEIE, pages 42-47, Capri-Italy, May 1999.
- Authier M. & Lévy P. (1992), *Gli Alberi delle Conoscenze, Educazione e Gestione Dinamica delle Competenze*, Italian version edited by Feltrinelli 2000.
- Battisti F.M. (1991), *Educazione a distanza e sistema universitario*, «Rivista di studi politici», year III, no. 3, pages 15-33. On the Internet, <http://www.fr.flashnet.it/alinet/battist.htm>
- Battisti F.M. (1992), *Scuola società e cambiamento tecnologico*, Esi, Napoli.
- Berners-Lee T. (1999), *Weaving the Web; The Original Design and Ultimate Destiny of the World Wide Web by Its Inventor*, Harper, San Francisco.
- Castelfranchi Y. & Stock O. (2000), *Machine come Noi: La scommessa dell'Intelligenza Artificiale*, Laterza Editori.
- Conte R. & Castelfranchi C. (1995), *Cognitive and Social Action*, UCL Press Limited, University College London, Gower Street, London.
- Gilbert N. & Conte R. (1995), *Artificial Societies: the Computer Simulation of Social Life*, UCL Press, London.
- Giuli D. (2000), *Dalla persona alla tecnologia alla Rete Globale*, Workshop on “Soggettività e Rete Globalizzante: percorsi di ricerca dei limiti strutturali e dei connessi adeguamenti tecnologici ed operativi”. Faculty of Engineering, Florence 30 October 2000.
- Giuli D. (2001a), *Background and Objectives of the B.E.S.T. Beyond Internet Framework Research Program*, Dept. of Electronics and Telecommunications, University of Florence, Internal Report DET-1-01, February 2001.
- Giuli D. (2001b), *Subjective Information and the Subjectivizing Gene for a New Structure of the Instrumental Relation and Interaction Processes in the Global Network*, Dept. of Electronics and Telecommunications, University of Florence, Internal Report DET-2-01, February 2001 (in Italian).
- Giuli D. et al. (1997), Gruppo di Lavoro MURST su Formazione aperta e a distanza: Università e Istruzione Superiore.
- Ivaldi I. (1999), *Ergonomia & Lavoro*. Liguori Editori.

- Jacobson M.J. & Spiro R.J. (1994), *A Framework for the Contextual Analysis of Technology Based Learning Environments*, Journal of Computing in Higher Education, 2(5): 3-32.
- Jonscher C. (1999), *The Evolution of the Wired Life, from the Alphabet to the Soul-Catcher chip – How Information technologies change our World*, John Wiley & Sons.
- Katz Richard N. & Associates (1998), *Dancing with the Devil, Information Technology and the New Competition in Higher Education*. Price Water House Coopers, EDUCAUSE.
- Kershaw A. (2000), *Delivery and Support of On-line Learning Clues from Chaos Theory. Proceedings from ONLINE EDUCA BERLIN, 6<sup>th</sup> International Conference on Technology Supported Learning and Training* November 30 – December 1, 2000, pages 248-249.
- Kevin M. (2000), *The Learning Curve*, EDUPORT, Winter 2000. On the Internet, <http://www.eduport.com/community/kiosk/>
- Lessig L. (1999), *Code and Other Laws of Cyberspace*. Basic Books.
- Lévy P. (1997), *Il Virtuale* Raffaello Cortina Editore.
- McLuhan M. & Powers B.R. (1989), *The Global Village. Transformations in World Life and Media in the 21<sup>st</sup> Century*. Oxford University Press.
- McMurra E. (1999), *EPFL en ligne; les nouvelles technologies de la formation a l'EPFL*. In *Flash Informatique EPFL*. On the Internet, <http://sawwww.epfl.ch/SIC/SA/publications/FI99/fi-sp-99/sp-99-page5.html>
- McMurray E. (2000), *Des normes pour les technologies de la formation*. In *FLASH INFORMATIQUE EPFL*. On the Internet, <http://sawwww.epfl.ch/SIC/SA/publications//FI00/fi-4-00/4-00-page3.html>
- Pettenati C. (1996), *Bibliothèques virtuelle, bibliothèques numériques*. In *La recherche d'information sur le réseaux*. INRIA September-October.
- Pettenati C. (1999), *Nuove tecnologie per la gestione del profilo dell'utente* Biblioteche Oggi, XVII (5): 6-11.
- Pettenati C. (1999a), *Le riviste Scientifiche elettroniche e le biblioteche*. IF journal of the IBM Italia Foundation, Vol. 3.
- Pettenati M.C. (1999b), *Design and Evaluation of a Web based Environment for Teaching and Learning* Ph.D. Thesis University of Florence.
- Pettenati M.C., Abou Khaled O. & Giuli D. (2000), *Technology and Pedagogy; developing a Webagogy*, submitted to Journal of Interactive Learning Research, AACE.
- Pettenati M.C., Giuli D. & Pettenati C. (2000a), *Network Based Educational Environment: How Libraries and Librarians Become Organizers of Knowledge Access and Resources*. International Conference on Information Technology Based Higher Education and Training Istanbul, Turkey; 3-5 July.
- Pettenati M.C., Giuli D. & Abou Khaled O. (2000b), *Information Technology and Staff Development: Issues and Problems Related to New Skills and Competence Acquisition*. Accepted by Journal of Technology and Teacher Education (JTATE). AACE.
- Reeves T.C. (1997), *A model for the effective dimension of interactive learning on the World Wide Web*. On the Internet, <http://itech1.coe.uga.edu/Reeves.html>.
- Rifkin J. (2000) *The Age of Access: The New Culture of Hypercapitalism, Where All of Life is a Paid-For Experience*, J.P. Tarcher.
- Shannon C.E. & Weaver W. (1963), *The Mathematical Theory of Communication*, Illinois University Press, Urbana.

- Shapiro Andrew L. (1999), *The Control Revolution; How Internet is Putting Individuals in Charge and Changing the World We Know. A Century Foundation Book.*
- Van Herwijnen (2000), *The impact of XML on library procedures and services* – High Energy Physics Libraries Webzine Issue 1. <http://library.cern.ch/HEPLW/>
- Zastrow J. (1997), *Going the distance: Academic librarians in the virtual university Proceedings of the Twelfth Computers in Libraries Conference.* Arlington, Virginia.

# TOWARDS AN OPEN AND FLEXIBLE UNIVERSITY

Camilla Tartoni  
e-mail: tartoni@unifi.it

## **Two dimensions of higher education: flexibility and virtuality**

The starting-point for our observations is the analysis of two attributes which are increasingly characterising education, and in particular on-line education: flexibility and virtuality.

One of the features of the university population is its increasingly greater diversity, with new groups emerging which express the need for more flexibility, such as the students-workers who, in the academic year 1997-98 alone, in Italy accounted for more than 80% of the enrolled students (AA.VV., 1999, p. 4). Incentives in this sense include enhanced curricular personalisation and the absence of attendance requirements in many degree courses.

In general, it can be observed that many universities and other higher education institutions are responding to this change by making their offer more flexible, providing a wide range of courses which can be developed through diversified situations, including part-time study and distance learning. In this respect the role of communication and information technologies is crucial, since it can enable the distribution flexibility which many adults require in order to access education. The courses can be followed from home, from work or from local centres. What we are speaking of, therefore, is flexibility at a number of levels: administrative and managerial flexibility, organisational, educational and didactic flexibility, and the flexibility of the structures, contents and materials.

The administrative and managerial flexibility relates to the use of databases, the computerised management of enrolments and data, and the organisation of part-time, evening and intensive courses and those designed specifically for working situations.

In organisational terms the flexibility is defined in the selection of course types (traditional, parallel, mixed etc.), in the choice of the format for presentation of the contents, in the definition of phases and in the management of the staff for both teaching and support activities (designers, teachers, tutors, technicians, advisers etc.).

The educational and didactic flexibility relates to a greater adaptability in the form and contents of the courses, in the way in which they are run, and in terms of materials. It should also provide more flexible learning approaches, in terms of the individualisation and personalisation of the curricula, collaboration and co-operation.

In short, flexibility is understood as an enhanced accessibility to education for groups of "new" users, as the chance of offering the students a broader range of educational proposals and higher quality in the education itself. It also implies an enhanced control over modes of learning, with students being encouraged to be more responsible for their own learning processes, and the provision of greater support for independent learning and self-education.

The other dimension is that of the virtual. The definition of virtuality given by Websters New International Dictionary (2<sup>nd</sup> edition, 1953) is: *Being in essence or effect, but not*

*in fact*, the definition refers to areas of virtual learning that can be studied, created, stimulated etc. These are areas that have no boundaries and that are open to any interpretation. The virtual is characterised by the “passage from the internal to the external and from the external to the internal”. This *Moebius effect*, as is underlined by Pierre Lévy to whom we owe this definition, outlines the mixing of the areas of action (Lévy, 1997). The traditional worker, for example, had his or her office, while the collaborator in a virtual business instead shares the virtual and computerised premises with other employees. The private area of the worker operating from home becomes a public area, as in the case of tele-commuting.

Areas become virtual and mixed in the same way in the sphere of education. Today, information and knowledge are the main sources of wealth. The relation with knowledge as it was experienced from the post-war period on, and particularly during the 70s was radically different. Up until the second half of the twentieth century, almost invariably the knowledge acquired by an individual during his/her lifetime would be handed down to the children; in effect knowledge was transmitted from generation to generation. Now all this has changed, not only does knowledge alter at an unparalleled speed, but we also have to continually update our knowledge if we want to survive the contingencies of daily life. Knowledge has a much shorter life cycle. Some even advance the hypothesis of a three-year cycle (Lévy, 1997), for example in the case of computer knowledge. That is, we have passed from the putting into practice of a stable knowledge, which used to constitute the basis for all activity, towards an ongoing education, *lifelong learning*. The knowledge that was once background is now in the limelight and has become a “flow” of information. Information and knowledge are now considered primary economic goods.

The most stimulating impact on higher education of these two dimensions of flexibility and virtuality can be traced to the learning strategies and to more open, flexible and distributed modes of teaching.

#### *Distance, open, flexible and distributed learning towards a model of virtual education*

From the 70s on the birth of the “Open Universities” gave rise to a new model of university throughout the world which, by applying teaching methods linked to the concepts of *distance learning* and *open learning*<sup>1</sup>, augmented the educational strategies aimed at enhancing the learner’s autonomy and responsibility.

The terms *open* and *distance learning* can overlap but distance education can not always assimilated into *open learning*.

The key concepts to be respected with so that education may qualify as “distance” learning are the following: physical separation between teacher and student; independence of the educational activity from the moment of the delivery of the teaching; a structured teaching organisation, that is, one which depends upon a scholastic institution; the existence of some technology to connect the teacher to the student; the systematic use of a

<sup>1</sup> For a more thorough examination of the differences in the definitions of distance education and open learning see Calder & McCollum 1998; Harry, 1999; Morabito 1999

remote and virtual learning; the possibility of a two-way, interactive communication; an industrialised form of teaching with clear objectives, criteria and study rules.

Over the last two centuries the models of *distance learning* have evolved through three generations (Garrison 1985, Nipper 1989, Trentin, 1998). There was the nineteenth-century model, where education took advantage of the development of the railway network for the extensive distribution of the teaching material (*correspondence learning*). The model which developed in the 60s and 70s, influenced by mass-media technologies (television) and by a rationalistic and objectivistic approach to knowledge, based on curricular design, didactic units and objectives to be reached. Finally there came the 80s model, in which communication and learning were considered as social processes based on the utilisation of data communication networks and computer conferencing.

The term *open learning* has become widespread in the United Kingdom, even though in America the expression *independent learning* (Keegan, 1994) is preferred. Internationally, preference is given to the generic term *distance education* (Moore, 1990). The term *open learning* derives from the experience of the Open University, an institution representing the historically most interesting model of adult education. Since 1971 this educational agency has continued its activity as an autonomous university, largely financed by the British government, with the purpose of giving a second chance to adults who had not been able to benefit from higher education. With the help of able teachers and modern communication technologies, new low cost and easily accessible courses have been developed, backed up by systems of assistance and consultancy to adapt the studies to the individual needs of the students. Today the British Open University currently has students in over 41 countries throughout the world. It is the largest university in Great Britain with more than 200,000 students, representing 21% of all part-time higher education students in the country.

Returning to the definition of the term open learning, we can see that this indicates a teaching system structured with minimal space and time restrictions, in which students are given a certain margin of decisional independence in the learning process. Peters recognises eight principles delineating the philosophy of open learning: (1) the acquisition of knowledge is open to all (*the equality principle*); (2) the learning takes place without distinctions of gender, social or cultural level, membership of specific groups etc. (*the principle of equality of opportunity*); (3) the learning can take place at any time and place, without reference to specific periods of life (*the principle of lifelong and ubiquitous learning*); (4) the teaching programmes must not be completely pre-established and defined but must be "open" to unexpected developments in individual capacities (*the principle of open curricula*); (5) the course must originate from the prospectives, the interests and the experiences of the individuals involved in the learning (*the principle of learner-relatedness*); (6) the students can organise themselves and study independently (*the principle of autonomous learning*); (7) learning is based on interaction and discussion (*the principle of learning through communication and interaction*); (8) the learning takes the reality of everyday life into consideration (*the principle of relatedness to everyday life*) (Peters, 1998, p. 98).

The crux of the teaching-learning process is represented by the teacher's possibility of setting up an appropriate communication channel with the student. It is therefore fundamental to specify the range of communication media available to each student.

In terms of teaching methods, the chosen methodologies must maximise the potential of the learning process for each student, while at the same time ensuring the circulation of ideas, and confrontation between the various members of the learning group.

In the 80s, the development of electronic technology ushered in a new revolution, and for the first time in history “face-to-face” contact at a distance became possible: satellite systems, video-conference systems and web systems have linked up the entire world. In January 2000 a million courses were available on the Web; at present there are 33,000 courses listed on the Telecampus site (<http://www.courses.telecampus.edu>). Changes in technology and communication have led to the creation of virtual associations and public virtual universities, they have in other words brought the university to the student’s desk. Thus from this part too the emphasis is laid on individual-centred work and on learning groups. A concept of *flexible learning* is being developed, a term the popularity of which is increasing, especially since many universities in Australia have created *Flexible Learning Centers*. The term “flexible” (*flexible delivery* or *flexible learning*) is often confused with “open” and refers to an educational offer ranging over varied formats which can be utilised both *on* and *off* campus. According to Moran and Myringer’s definition, learning can be considered flexible if it is student-centred, if it is free from restrictions of space and time and learning/teaching methods, and if it uses appropriate web technologies (Moran & Myringer, 1999, p. 6).

Calder and McCollum highlight five key points in the organisation of flexible learning: (1) to take into account the learning needs of the individuals; (2) to make users more responsible for their own learning; (3) to make effective use of the resources; (4) to allow the differentiation of learning; (5) to support the work of the staff and students. The flexibility of the learning is due to a greater adaptability to the needs of the individuals, developed through modular strategies, through the crediting of skills acquired in the past, and the personalisation of the curricula (Calder & McCollum, 1998).

The evolution of data communication and information technologies have brought about a re-definition of the self-education and distance training models. In the models of distance education the use of the *disputatio* has been rediscovered through interaction and dialectic, and the tendency is to place education within a negotiable, co-operative and multicentric concept of learning. Learning becomes distributed, that is a concept of *distributed learning* emerges which tends towards the contemporary development of personal and collective knowledge. In this sense, what is highlighted is the chance of promoting an authentic community of knowledge and research, by learning to participate, as Lévy claims, in the collective production of meaning (Lévy, 1996).

The current period, according to Keegan, is characterised by *E-learning* that is by electronic learning which differs from *D-learning* (distance learning) in that it introduces the electronic factor into traditional distance education. The near future of distance education will be characterised by the widespread use of mobile phones and by wireless connections. This model is defined by Keegan as M-learning (*mobile learning*), a kind of teaching without mobility restrictions performed via mobile phones and computers through the development of WAP, GPRS and *bluetooth* technology. Wireless Internet reaches the student at any place or time.

From the residential university we have moved on to witness the birth of the “portable” university of the third millennium, a type of university which is, moreover, already in existence beyond the confines of Italy. The education of the twenty-first century can be defined as follows: open, in that it is updatable, adaptable, usable by anyone anywhere; *flexible* because it allows multiple modes of delivery and use, which can be fitted to the individual and the territorial context; it is also characterised as *lifetime learning* because it enables a continuous and recurrent learning system, free from the classic time and age strictures of institutional education; finally it is *distributed* in that it allows the sharing and the co-operative construction of knowledge, and the sharing of virtual spaces as sites of discussion and the production of arguments. In this context the role of the university is changing, and the very concept of site of knowledge or of knowledge located in a single place is giving way to a concept of disseminated knowledge that can be used “anywhere and by anyone”. These models are not free from economic, political, or still less educational, implications and as a result they call for critical analysis and careful reflection.

### Virtual universities

Online universities, as highlighted by Rossman (1992), are becoming the centre of a new Renaissance. In historical terms the end of the 20<sup>th</sup> century can be compared to the period of the growth of the universities in western Europe, which enhanced and enabled the development of the Renaissance. Knowledge was international and students often travelled in search of courses to attend. This system is very close to the modern methods of distance universities, where through electronic means students can choose courses in universities all over the world. In the seventeenth century, erudite scholars travelled throughout Europe to attend lessons and specific courses. Today the “Web surfers” travel like seekers of wisdom to reach the containers of knowledge located in different places. This gives the individual more independence; he/she can freely select *what* information he/she wishes to access, as well as *how* in terms of methodology. But the flexibility is also implicit in *when* he or she is going to do this, obliging the individual to assume maximum responsibility in the building of his or her own learning process. There has been a shift from a physical place to one which is virtual, but no less real, where all, or almost all, the processes of knowledge can take place. The university has been “virtualized”.

University education can take different forms. The *dual model* exploits both face-to-face and distance learning. Then there is a hybrid or *mixed mode* model which attempts to combine the potential of communication-based learning technologies with the traditional *face-to-face* teaching method. The universities offer a range of courses, some conventional, others through Internet and related technologies. This composite model exploits the different potentials of the network, both infrastructural (the possibility of reaching remote users and teachers, distributed knowledge etc.) and methodological (self-education, collaborative work, methodologies for the design and construction of learning and training itineraries etc.). The students and the staff use the Internet for access to the resources and many educational courses make notes and materials available (Rumble, 1997; Peters, 1998; Ryan et al., 2000).



For some years now, the *virtual mode* has also been emerging, adopted by universities delivering exclusively virtual courses through appropriate software environments. The university, in its virtual dimension, exploded during the last decade of the twentieth century and is now diversifying in a variety of parallel solutions, both integrated and distributed (Rossman, 1992; Ryan et al., 2000). The virtual university is an institution that has developed as a direct supplier of learning opportunities for students, which uses communication and information technology to distribute its programmes and courses and to provide back-up lessons (Ryan, 2000). It performs activities of administration, marketing, student registration, development, production and distribution of materials, distribution of lessons, of learning and evaluation. It offers a learning environment on the Web which enables the active support of collaborative learning and the construction of inter-disciplinary knowledge as a process aimed at the progressive solution of problems and the development and acquisition of expertise. It is characterised by the flexibility of an integrated learning environment which is linked to videoconferencing systems and educational resources (Harasim & Campos, 1999). A virtual university is envisaged as a virtual space characterised by the presence of several typical environments in which teaching activities are delivered which are more or less integrated by virtual classes, where data are collected, materials purchased, where the necessary administration is performed and where one can chat (environments of: *teaching, research, topnews, shop, cafeteria, office, library, information*).

### **The role of virtual universities in the global market: The World University**

Millions of students follow courses electronically, many students use electronic networks for global (world) research projects, and there are other signs indicating the emergence of a worldwide university network. Groups of designers have been wondering whether a disordered system just cannot be avoided or whether all the consortia, individual universities, educational centres etc. might be organised into a global system of knowledge. Should the ideal university be centred in a single, albeit virtual, place or distributed throughout the world? Can knowledge be monopolised by “mega universities” (Moore, 1990)<sup>2</sup> or distributed over small, physically distant centres of education and research?

The scenarios of professional training, both formal and informal, are rapidly changing and what is immediately striking is that the new education emerging from the network and in the network is no longer based upon one cultural centre which delivers the education, but upon multicentric structures within which cultural and educational values and contents are reconsidered and redistributed in a number of directions. A host of new organisations are coming into being; these include international agencies and organisations, alliances and profit-making corporations which administer the courses through educational agencies, non-profit research, promotion and documentation centres, professional organisations managing their own training, vertical broadcasting networks via satellite, horizontal telecommunication networks, mega universities, university consortiums and

<sup>2</sup> These are the educational superstores delivering standardised courses on a global scale through a global media chain. This model (*British Open University, Athabasca University*) can guarantee uniformity of delivery and high quality courses at very competitive prices

virtual campuses. In short, the educational world is being transformed into a global marketplace. Active participants in this process have proved to be individual universities – and sometimes individual departments – university tele-teaching consortias, and private university-type institutes.

One of the most important associations, set up in 1991, is the National Technological University (NTU), a consortium of 40 university engineering departments, almost entirely financed by students' tutoring and the associated firms, which supplies distance courses to more than 1,100 students. Alongside such consortiums, another widespread solution is that of the co-operative alliances set up between several agencies, the method used by the Commonwealth of Learning (COL) created by 50 governments to expand the opportunities of distance education in their respective countries. These governments decided to use simple systems through which the colleges, universities and other Commonwealth institutions can work in a co-operative manner. In practice, to establish a network for the divulging of experience, these countries are creating what could be defined a "consumer co-operative" to co-ordinate trans-national distance education programmes (Rossman, 1992). It should be remembered that the commitment of the COL is also directed towards the Third World, to students for whom it perhaps represents the only *chance* of obtaining a high quality education.

In Italy one of the most important consortiums is Nettuno (University Tele-teaching Network) operating predominantly in the university diploma sphere through initiatives which are complementary to those of the member universities; here the methods used are rapidly shifting from more traditional distance learning to an effective online delivery of courses via Internet.

In general, what we can observe is the widespread trend towards alliances between professional and educational agencies aimed at the creation of increasingly broader networks of relationships and support, that is, a trend towards the construction of a *world brain* (Wells, 1938) connecting all the major universities in the world. This is the solution pursued by the University of the World Project, a project started in California in 1983 by a group of people who had already been working on the EDUCOM Project, a non-profit consortium of 600 North American universities which has for years been offering publications and information on the relation between university education and *information technology*. One of its main objectives is the creation of a worldwide network of universities which will enable all users to access important research and information. The University of the World Project is aimed at setting up a network connecting all the universities in the world. The GEA (Global Educational Associates) is attempting to impose some restrictions and to draw up guidelines for the development of a world university, and consequently for the system through which online courses and materials are exploited from every corner of the globe.

### **Teaching in the virtual university**

Some virtual universities are directed toward a contents-centred teaching, that is they use the potential of the network to transmit knowledge and sometimes to evaluate the learning level. Belonging to this type are all those institutions which offer educational

packages with multimedia teaching materials (from CD-ROMs to online texts) and diversified online supports (tutors, advisers, experts etc.). In such cases the students download the materials and follow the learning instructions offered to them, requesting information, suggestions and clarifications up to the moment of the final assessment, which sometimes also takes place online. The theory underlying this model of distance education, the direct descendant of traditional correspondence learning, is that of self-education and autonomous learning. This model tends to focus on the active role of the individual, pivoting on his/her interaction with the resources, the materials and the tutor.

Other universities, instead, adopt a model based on theories in which the individual students are seen as actors in the educational process. According to the universities which implement this philosophy, we can reproduce online the dynamics which normally develop in a classroom. Role differentiation in co-operative work, collaborative work on common projects learning support among students, asking questions and seeking information, the exchange of opinions and getting acquainted, are all within the context of a class made up of students in different and very often distant locations. What emerges, therefore, is a *virtual class*, that is a network environment where part or all of the interactions which take place in a traditional classroom are simulated online (Woodall, 1999). The first university faculties offering online courses simulated traditional classroom settings through the use of syllabuses, cards, course notes and discussion rooms, with the additional opportunity to communicate with teachers or other students via e-mail, electronic bulletin boards, chat rooms and forums. The simulation capacities of online environments, and the free access they offer to both the teaching itself and external resources, constitute significant advantages over traditional classroom lessons. (Hazari, 1999). The virtual class is thus identified as a superimposition of the traditional physical learning space, that is, as a “virtual” learning space. The virtual class appears to be one of the most interesting teaching models in terms of university education (Harasim et al., 1995; Rowntree, 1995; Draves, 2000). In general, emphasis is placed on the metaphor of the classroom as a context of social interaction, albeit virtual, between the various actors in the process: teachers, administrative staff, tutors, advisers, students etc. This second model tends to stress the aspect of reciprocal help and mutual co-operative teaching which emerges in a problematic situation or, more simply, in a team.

Here it is however important to point out that, in different virtual university experiences, the type of interaction is marked by a greater or lesser degree of flexibility, and such universities do not always reveal the features illustrated in the two “extreme” models presented above (Rowntree, 1995) that is, those of self-education or the social construction of knowledge. The different educational approaches take on forms which are a mixture of self-education and the collaborative construction of knowledge, and they tend to exploit, within the same teaching framework, both one-to-one interaction (that is between student and tutor) one-to-many (teacher and students, expert and users, as in videoconferences) and many-to-many interaction (that is, not only in a vertical direction as in one-to-one or one-to-many communication, but also at a horizontal level between different experts and, above all, among the students themselves). The interaction among students may even not be planned by the project-making staff and hence not explicitly requested,

developing instead autonomously and naturally as a form of social and motivational support or, as often happens even in the simplest and most circumscribed experiences, as a shared, public, critical reflection on the educational project being offered or proposed. As in face-to-face education, these dynamics represent an integral part of the learning process, and are more specifically a completing factor of the educational process which develops online.

Online the figure of the *tutor* emerges forcefully, an extremely complex role since, in addition to having the *knowledge of content* proper to the teacher, he/she must also necessarily possess *knowledge of method* so as to perform the teaching correctly, and *knowledge of process* to increment the students' learning and create situations and environments favourable to the construction of knowledge. The tutor possesses skills as a designer of learning itineraries, an animator of discussions and an evaluator of educational processes; he/she is also a conductor of situations, an animator of the atmosphere in the virtual classroom and a therapist attentive to the needs and requirements of the students. In addition to all this, he/she also has technological skills, so as to be able to adapt itineraries and contents, facilitate access to information, expand knowledge and communication, and promote critical reflection and argument for an aware and intentional form of learning and knowledge growth. Finally, the online tutor in the virtual university has the task of confirming the reliability of the practical project (the training practice, workshops, research and experimentation activities etc.) and of evaluating the student's learning. The online tutor is an instructor, a facilitator, a moderator and an animator but, above all, is a landmark – the pivot and the support for the learner. In short, transferred to the virtual dimension, the tutor retains the features of guide, adviser and certifier, a characteristic of the traditional face-to-face system while, at the same time, taking on extended and diversified functions on the basis of the teaching strategies and technological tools utilised<sup>3</sup>.

### **The problem of the quantity/quality ratio in online education**

The problem of the relationship between quality and quantity in online higher education courses is still much debated and remains an open question. We have seen how virtual education is broadening the educational offer, bringing higher education closer to the rules of the economic marketplace. How can we assess learning activity in a distance system? Through the system of university credits, recently introduced into the Italian university regulations, which has launched a quantitative assessment of periods of self-education through books, and those of face-to-face teaching in class? In online education these two activities are variably determined and difficult to differentiate. The traditional lesson, although it continues to exist through the use of videoconferencing or videocassettes systems, is less significant and its use is reduced in favour of multifunctional teaching materials: CD-ROMs, cards, course notes, raw or finished material that can be downloaded from the internet, contents sites, online resources differentiated by type, co-operative proj-

---

<sup>3</sup> At this point an observation has to be made. In Anglo-Saxon systems the tutoring model is extremely dominant. A model of this type proves much more difficult to adopt in Italy where, even where tutoring does exist, it is seen as a burdensome duty to be offloaded onto researchers or non-teaching staff, who are generally less qualified

ects and groupware environments etc. In a face-to-face course the teaching material may be a simple support designed to integrate the oral lesson being directed by the teacher, who may adapt, complete and integrate the lesson as he or she goes. In distance courses this is not so simple: the contents, their formal attributes (structure of the information, download potential of the material, legibility of contents etc.), and those relating to knowledge (exhaustiveness of information, completeness of contents, the effectiveness and adaptability of knowledge and its incremental potential etc.) are central and essential elements of the entire educational process. Communication interactions are important but sometimes accessory, depending on the strategies used in the course. An attempt has been made in online education to make a quantitative assessment of how many hours of education the study of a certain subject corresponds to, for example 50 written pages correspond to about 10-15 hours of study for a student (Calvani & Rotta, 1999); but the question is much more complex, since the materials, in addition to their being conveyed through different media and multiple symbolic codes demanding different reading and exploitation times, are also characterised by modular degrees of complexity.

Another widely debated problem is the quality of the learning materials. The preparation of “quality” materials for distance university courses is no simple matter. Face-to-face lessons have their difficulties, but when the teacher is in command of the contents, sometimes all that is needed is a series of simple diagrams to remind the student of a programme or a logical sequence, combined with a degree of awareness on the part of the teacher of the students’ explicit and implicit requirements.

A factor which ought to contribute to the determination of quality is the “visibility” potential imposed by the network. Once the elaborated products and materials are put online, they become public and easily accessible, but at the same time equally open to observation, evaluation and criticism. This second aspect ought to provide a sort of deterrent, guaranteeing a certain degree of quality in the products distributed online.

Many universities have set up co-operatives, signed agreements and developed alliances to guarantee, on the one hand, a degree of quality in the technology and the management of the hardware and software infrastructure and, on the other, to create “centres of excellence” for the quality control of the contents and teaching materials. One of the most famous is the Centre for Excellence founded by Linda Harasim in Canada. All material produced has to be inspected by a team of experts which guarantees the quality. Only in this way can the university maintain its hegemony in the educational sector and its credibility as a centre of knowledge production.

The problem of quality, which in quantitative terms also involves the problem of the certification and recognition of the educational program, does not apply exclusively to the teaching products and materials but in general to the entire system of higher education online. Unlike the business context in which the concept of quality originated, the evaluation of any educational process is essentially problematic, as a result of the complexity of the subject in question<sup>4</sup>. In distance education it is necessary to implement forms of

---

<sup>4</sup> In general, we can observe two macro-trends in institutions dealing with higher and university education: a “calibrated” solution, featuring significant investments in human resources (tutors, teachers, experts, technicians,

evaluation, verification and monitoring in order to plan education effectively, and to identify itineraries and strategies that can be reproduced and transferred. Only by maintaining ongoing and diversified forms of evaluation (educational, aggregate, systematic, qualitative and quantitative), monitoring, and comparison with other teaching and learning strategies is it possible to maintain a level of quality in terms of costs and teaching effectiveness. Moore (1998) highlights four elements which, more frequently than others, negatively affect course production. The first is the tendency to identify the quality of the education with the costs of the technological infrastructure, whereas without appropriate education strategies, the latter cannot constitute an aspect of efficiency or guarantee the quality of the educational process. There is, on the contrary, a close connection between the quality of the planning and design of the programme and the preparation of the course staff. In the second place, Moore points out the tendency of the organizing team to identify the presentation of the information with the actual knowledge and learning itself. In order to guarantee a certain quality level, a higher education system must not only deliver reliable, exhaustive and comprehensible contents, but it must also enable a high degree of interaction between the learner and the information so that the individual can internalise it and transform it into knowledge. The moment of interaction therefore assumes a crucial importance and, like the materials, demands careful and precise planning. A third quality element involves the members of the team. Frequently, when university teachers and figures from the traditional face-to-face higher education system experiment the preparation of online lessons and courses, they continue to adopt the face-to-face strategies and methodologies. This, claims Moore, is one of the most widespread errors, since teaching through the use of online tools has its own specific characteristics and if we want to have an effective quality system, we must keep this clearly in mind. In face-to-face learning the context is an indispensable yet obvious element; in virtual learning it assumes different connotations for at least two reasons. The first reason is that the context of interaction is the network, so that all interactions take place at a “virtual” level, that is mediated by a technological infrastructure and a software environment. The second reason is that the context in which the courses and educational models are produced does not always correspond to the social and cultural requirements of the context in which the course is used, giving rise to misunderstandings in terms of communication and meaning which can have a negative effect on learning and invalidate the quality of the course itself. Finally, there is also a tendency to think that the process should be centrally controlled but, as we have seen, the trend of virtual higher education is towards decentralisation, with the support of territorial centres which are in fact very difficult to control.

---

advisers etc.) and an “integrated” solution which is more concerned with setting up the technological infrastructure (Calvani & Rotta, 1999). The former relies on the presence of a vast and varied staff which comprises figures to back up the various stages of individual learning; it generally employs “poor” or common technologies which risk becoming imminently obsolete, and cannot therefore, in financial terms, guarantee any major scale economies. The “integrated” solution, on the other hand, strengthens the technological aspect to the detriment of support structures and of the presence of tutors and advisers who could increase the qualitative level of learning. These macromodels are, however, accompanied by a series of intermediate solutions that tend to bridge the gaps between the two.

To these four points a fifth can be added as a reflection. Good planning and a good preparation of the teaching materials, completed by adequate technological infrastructures, are still not sufficient to produce a qualitatively effective system. Very often the online education modules are disregarded and only partially exploited, as a result of an – albeit undeclared or unclarified – lack of technological familiarity. If we cannot access the media, then we cannot access the knowledge, a statement which is equally true for face-to-face and distance learning, although clearly with repercussions of greater significance for virtual education.

### **Concluding remarks**

Higher education is changing rapidly and a series of pressures, including that towards the globalisation of the market, are calling for a reconsideration of the systems, methods, techniques and schedules of education, modifying the forms of supply and demand. Education is assuming a recurrent, continuous and lifelong character, and its boundaries are undergoing remarkable changes because no longer bound by limitations of space, time and place. At the basis of the rapidly spreading new strategy is the use of the network for the delivery of different educational approaches – open learning, distance learning, independent study, self-education etc. – while at the centre of the current pedagogical reflections on education is the awareness that there exist a set of strategies and methods which serve to design and develop teaching materials and an integrated system of strategies to promote student-centred learning.

Certain reflections of a general character – such as the spatial/temporal independence of learning, the personalisation of curricula and of teaching methodologies, the cancellation of distances, the access to knowledge etc. – direct us towards an enhanced use of technologies for higher education. The students need more flexible, adaptable and accessible methods of education; there exists a whole population of new students (millions are forecast in the next decade) which ought to provoke the expansion of the education market and the development of new knowledge. In any case these elements should make us reflect on the fact that learning technologies can transform the way in which knowledge is presented, packaged, acquired, distributed and evaluated, and that such transformations are not always synonymous with improvement and progress. The emphasis placed on the rapid changes in media and the ease of distribution of the educational packages should not distract us from reflection and pedagogical research into educational models and methodologies, especially at a time when technological progress is altering the very heart of higher education in terms of both modes of production and distribution strategies.

The crisis of knowledge is real, but the university must be conscious of its role in the production and divulgation of knowledge, and must bring to the fore its inherited credentials as a site of openness and critical reasoning. The academic world, is legitimised by its capacities for information, research and the transmission of knowledge, but such capacities must now be established and secured via a new world which is vast, flexible and difficult to dominate the virtual world of the net (Barnett & Friffin, 1997).



Virtual University is the largest educational portal for the virtual university.  
(<http://www.vu.org>)

*The dimensions of the phenomenon of online education in the Anglo-Saxon world are obviously vast and articulated. The range includes specialisation courses for secondary school leavers, postgraduate courses, educational courses for senior citizens, etc.*



CyberEd University offers a vast catalogue of online courses.  
(<http://www3.umassd.edu>)

*To get an idea of the dimensions of the phenomenon of online education, visit the site of the Virtual University, the largest education portal for the virtual university.*



*The dimensions of distance education are considerable. We have only to consider that the market for open distance learning has been estimated at about 300 billion dollars (Ryan et al., 2000) For a selection of university courses consult the site of the CyberEd University of the University of Massachusetts.*

*The Virtual University is a Web environment that reproduces educational locations. In these environments, it is possible to tour the university campus, consult the catalogues of courses and educational opportunities by leafing through electronic databases and guides, visit the library and borrow books, enrol for university diplomas or language courses, meet people and talk to them etc.*



## BIBLIOGRAPHY

- AA.VV. (1999), *Le nuove tecnologie e la didattica universitaria a distanza*, Atti del Convegno, Giuffrè Editore, Roma, 28<sup>th</sup> January 1999.
- Barnett R. & Friffin A. (1997), *The End of Knowledge in Higher Education*, London, Cassel.
- Bellotto M. & Trentin G. (1989), *Culture organizzative e formazione*, Milano, FrancoAngeli.
- Bruscaglioni M. (1990), *Specializzazioni e specificità nella professione formatore*, in "Rivista Aif", 8.
- Calder J. & McCollum A. (1998), *Open and Flexible Learning in Vocational Education and Training* London, Kogan.
- Calvani C. & Rotta M. (1999), *Comunicazione e apprendimento On the Internet. Didattica costruttivistica in rete*, Trento, Erickson.
- Calvani A. & Rotta M. (2000), *Fare formazione On the Internet. Manuale di didattica online*, Trento, Erickson.
- Cambi F. (1997), *Storia della pedagogia*, Bari, Laterza.
- Cesareo G. (1999), *Reinventare l'università: ricercare navigando*, in Carbone P. & Ferri P. (a cura di), *Le comunità virtuali*, Milano, Mimesis.
- Cooper C. (1996), *Guidance and Coherence in Flexible Learning*, in Raggatt P., Edwards R. & Small N., *The Learning Society. Challenges and Trends*, London and New York, Routledge.
- DeMaio D. & Utsumi T. (1991), *Using Manual of Global Lecture Hall*, Bari, Laterza.
- Draves W. (2000), *Teaching Online*, River Falls, Wisconsin, LERN Books.
- Gagliardi P. (1984), *Configurazioni professionali nell'area della formazione*, in "Quaderni di formazione Pirelli", 52.
- Garrison G.R. (1985), *Three Generations of Technological Innovation*, in "Distance Education", n. 6, pp. 235-241.
- Ghislandi P., *Didattica flessibile e a distanza per l'Università e per la formazione permanente*, CTU Milano. On the Internet: <http://www.ctu.unimi.it/index.html>
- Harasim L.M. (1986), *Computer Learning Networks: Educational Applications of Computer Conferencing* in "Journal of Distance Education", 1(1), pp. 59-70.
- Harasim L.M. & Johnson E.M. (1986), *Educational Applications of Computer Networks*. Toronto, Ontario Ministry of Education Press.
- Harasim L.M. (1990), *Online Education: Perspectives on a New Environment*, New York, Praeger.
- Harasim L.M. (1993), *Global Networks: Computers and Communication*. Cambridge, MIT Press.
- Harasim L.M. (1997), *Interacting in Hyperspace: Developing Collaborative Learning Environments*. On the Internet, <http://www.umuc.edu/iuc/workshop97/harasim.html>
- Harasim L.M., Hiltz S.R., Teles L. & Turoff M. (1995), *Learning Networks: A Field Guide to Teaching & Learning Online*. Cambridge, MA, The MIT Press.
- Harasim L.M. & Campos M. (1999), *Virtual-u: Results and Challenges of Unique Field Trials*, July/August. On the WWW: <http://horizon.unc.edu/TS/vu/1999-07.asp>
- Harris J. (1995), *Educational Telecomputing Projects: Interpersonal Exchanges*, in "The Computing Teacher", Mining the Internet, Vol. 22, n. 6. On the Internet, <http://hrs.ed.uiuc.edu/Mining/March95-TCT.html>

- Harry K. (ed.) (1999), *Higher Education Through Open and Distance Learning* London and New York., Routledge.
- Haskins C. (1957), *The Renaissance of the 12<sup>th</sup> Century*, Cleveland, World Publishing Co.
- Havelock E. (1986), *La Musa impara a scrivere*, Londra, Laterza.
- Hazari S.I. (1998), *Evaluation and Section of Web Course Management Tools*, Retrieved from the Web. On the Internet, <http://sunil.umd.edu/webct>
- Keegan D. & Lata F. (eds.) (1985), *L'università a distanza: riflessioni e proposte per un nuovo modello di università*, Milano, FrancoAngeli.
- Keegan D. (1994), *Principi di istruzione a distanza*, Firenze, La Nuova Italia.
- Lauby P. (1987), *The New Challenge to Higher Education in Asia*, Break-Through, spring/summer.
- Lévy P. (1996), *L'intelligenza collettiva*, Milano, Feltrinelli.
- Lévy P. (1997), *Il virtuale*, Raffaello Milano, Cortina Editore.
- Lisco R. (1999), *Internet e le comunità virtuali. Nuove forme di apprendimento*, in *Le nuove tecnologie e la didattica universitaria a distanza*, Atti del Convegno, Roma, Giuffrè Editore, 28 January, pp. 59-69.
- Moore M.G. (1990), *Contemporary Issue in American Distance Education*. Oxford, Pergamon Press.
- Moore M.G. (1999), *Institutional Restructuring: Is Distance Education Like Retailing?*, in "American Journal of Distance Education", vol. 13, n. 1.
- Morabito M. (1999), *Online Distance Education: Historical Perspective and Practical Application* Dissertation.com, USA, Universal Publishers/uPublish.com.
- Moran L. & Myringer B. (1999), *Flexible Learning and University Change*, in Harry K. (ed.), *Higher Education through Open and Distance Learning* London and New York., Routledge.
- Nipper S. (1989), *Third Generation Distance Learning and Computer Conferencing* in Mason R.D. & Kaye A.R. (eds.), *Mindwave: Computer and Distance Education*, Oxford, UK, Pergamon Press.
- Olson D.R. (1985), *Linguaggio, media e processi educativi*, Torino, Loescher Ed.
- Ong W.J. (1986), *Oralità e scrittura*, Bologna, Il Mulino.
- Peters O. (1998), *Learning and Teaching in Distance Education*, London, Kogan.
- Piazzotta C. (1995), *Teleconferenze. Preparazione universitaria fatta a distanza. Ecco la scommessa di Trieste e Pordenone*, in "Italia Oggi", 11<sup>th</sup> November, ed. Italia Oggi Editori-Erinne S.r.l., p. 48.
- Riem G. (1999), *La teledidattica interattiva*, in AA.VV. *Le nuove tecnologie e la didattica universitaria a distanza*, Atti del Convegno, Roma, Giuffrè Editore, 28<sup>th</sup> January.
- Rivoltella P.C. (1999), *La scuola in rete*, Santhià, GS Editrice di Garfica Santhiatese.
- Rowntree D. (1995), *The Tutor's Role in Teaching via Computer Conferencing*, versione aggiornata per Internet da un articolo pubblicato sul "British Journal of Educational Technology", 26, 3, settembre. On the Internet, <http://www-iet.open.co.uk/pp/D.G.F.Rowntree/>
- Rossmann P. (1992), *The Emerging Worldwide Electronic University. Information Age Global Higher Education*, Contributions to the Study of Education n. 57, Westport, Connecticut – London, Greenwood Press.
- Ryan S., Scott B., Freeman H. & Patel D. (2000), *The Virtual University, The Internet Resource-Based Learning*, London-Sterlin (USA), Kogan Page.

- 
- Trentin G. (1998), *Insegnare ed apprendere in rete*, Bologna, Zanichelli.
- Trentin G. (1999), *Reti telematiche e Open Learning, dispense per il corso di perfezionamento a distanza* in "Multimedialità e didattica", University of Padua.
- Turoff M. (1995), *Designing a Virtual Classroom*, International Conference on Computer Assisted Instruction ICCAI 95, Taiwan. On the Internet, <http://www.shss.montclair.edu/useful/design.html>
- Wells H.G. (1938), *World Brain*, Garden City, N.J., Doubledaay Doran.
- Woodall C. (1999), *Becoming an Online Instructor*. IMG University Online. On the Internet, <http://www.imguniversity.com/sawyer/news/imgunews>

# THE UNIVERSITY AND VIRTUAL CLASSROOMS

Mario Rotta  
e-mail: mrxibis@ats.it

*A model is by definition that in which nothing has to be changed, that which works perfectly; whereas reality, as we see clearly, does not work and constantly falls to pieces; so we must force it, more or less roughly, to assume the form of the model.*

Italo Calvino, *Palomar*, 1983.

## **Virtual scenarios and educational contexts: trends and perspectives**

When the term “virtual”<sup>1</sup> is associated with an educational context or a situation with didactic implications, two diametrically opposed positions usually emerge. The first position sees in the virtual a strengthening of the real and an invaluable opportunity to resolve every problem: it imagines that thanks to the new technologies and the networks it is possible to construct a sort of improved model of reality, which can only enlarge the horizons of creativity and of knowledge (Negroponte, 1995). The second position, on the contrary, insists on the distance that separates the real from the virtual, underlining the way in which the risk of a progressive loss of contact with the real world is hidden in the virtualisation of any process: it is considered that the changes of perspective which a more intense use of Virtual Reality implies cannot be altogether “dominated”, to the point that we will no longer know how to distinguish between reality and “fiction”, or more simply, we will lose the taste for (and the value of) comparison with concrete experience (Zolla, 1992; Turkle, 1997). It seems difficult to consider one position wrong while admitting that the other is right: undoubtedly there is some justice in the affirmations dictated by enthusiasm just as in the most sceptical points of view, and it is still too soon to evaluate whether the virtual teaching and learning experiences have produced positive results or have opened up insoluble questions. This means that it is correct to aim at a more critical approach to the problem, but that at the same time it is wise to be open to experimentation and the exploration of new scenarios. Expectations or changes of mind, in fact, risk changing us into victims of what Philippe Queau (1995) evocatively defines as the “Lot’s wife syndrome”: we are living through “ a dramatic fracture, difficult to think about or to envisage through existing words and concepts”; much as we wish to face the future, in reality we are still very sensitive to the call of the past, so much so that we risk being turned to stone while looking backwards. Thus we should try to resolve the controversies on the meaning of the word “virtual” and instead think about how we can positively take advantage of the potential of Internet – seeing that the network is the virtual space *par excellence* – within contexts, such as that of university education, with complex but

---

<sup>1</sup> On the terminology and on the concept of Virtual Reality see also Maldonado, 1992; Rheingold, 1993; Lévy, 1997.

analysable features, in relation to objectives such as the development of the educational offer and the improvement in the quality of learning.

What does the construction of a virtual learning space imply? Can it be considered as only one of the forms of reality and thus one way of understanding or representing the real organisation? Or else, following the suggestions of *cyber* theory and aesthetics – which seem to have so much weight in all debates on the meanings and implications of online technologies – must we think of the virtual organisation as a sort of “storeroom of the intangible, a practical metaphor of the elusive” (Queau, 1995)? The debate is not idle, nor is it merely philosophical. On the contrary it concerns the possible strategies that can be put into effect to elaborate models of virtual communities, applicable to the university organisation as a whole, or to a learning group that is identifiable or recognisable as a “classroom”. In fact, if on one hand it is true that “we cannot think in terms of virtual and real as separate and consequently we must not imagine things in terms of substitution, but in terms of complexification, of imbrication, of redefinition, of opening towards new areas” (Lévy, 1997), on the other hand it is clear that the concrete problem of how to organise a virtual university necessarily implies taking up a position. In substance:

- *A virtual university can be a way of rendering usable at a distance services and contents produced in a real institution, which has its own physical seat and habitually functions as a structure and an organisation.*
- *A virtual university can, on the contrary, be an experiment in distance and online education which does not necessarily correspond to a structure operating in a physical space, or identified in a real institution or organisation.*

It might be said that in the former case the focus is, primarily, on the use of technologies as a medium for making usable at a distance material and educational experiences offered by the institution face-to-face or within its structures, and on the integration between traditional educational technologies and new technologies for teaching and learning. Instead in the latter case, the main problem is the definition of an acceptable model of virtual organisation, in the absence of a corresponding real organisation to which to refer, and above all the response to the need to identify the forms of involvement and of identification of the various individuals, whose social interaction space is uniquely constituted by mediations based upon the technology used. These two positions have repercussions, primarily upon the context within which scholars and operators are elaborating models and platforms applicable to the virtual community, or to the more localised interactions among the components of a defined group. Initially, it is a question of mapping out a sustainable strategy for re-engineering university education. For example, Stahlke & Nyce (1996) do not in general consider that the traditional approach has to be substituted by a new approach, based exclusively on use of the technologies and the virtual spaces that they open: on the contrary, they project a mixed situation, in which the technologies strengthen and extend the forms and the social learning and teaching spaces, introducing

elements which can free such processes from the spatial-temporal limits characteristic of traditional education. The virtual university assumes significance as an integrated environment, in which the relationships between teachers, students and resources become more flexible and elastic thanks to the possibilities offered by the new technologies. A virtual space, certainly, but only when the possibility for the specific use of a technological tool to facilitate a mode of interaction is seen, identifying an appropriate use of the various educational technologies related to specific objectives. On the basis of suggestions by these authors, we can draw up a table in which appropriate uses in the social context of learning are suggested for each educational technology or modality of interaction.

TECHNOLOGY OR MODALITY	APPROPRIATE USE
Electronic mail	<ul style="list-style-type: none"> <li>• Confidential communication</li> <li>• Asynchronous dialogue between single individuals</li> </ul>
Open mailing-list or newsgroup	<ul style="list-style-type: none"> <li>• Distribution of information to one or to many individuals</li> <li>• Open dialogue between components of a community</li> <li>• Open dialogue between components of an interest group</li> </ul>
Closed forum or newsgroup	<ul style="list-style-type: none"> <li>• Discussions aimed at specific subjects</li> <li>• Asynchronous discussions which must be kept in the memory for successive analysis</li> <li>• Distribution of information to groups</li> </ul>
Chatting	<ul style="list-style-type: none"> <li>• Exploration of subjects in real time</li> </ul>
World Wide Web	<ul style="list-style-type: none"> <li>• Distribution of hypertextual and multimedia material</li> <li>• Distribution of resources we wish to make widely accessible</li> </ul>
Streaming Video and broadcasting	<ul style="list-style-type: none"> <li>• Distribution of taped or simulated lessons</li> </ul>
Audio conference	<ul style="list-style-type: none"> <li>• Interaction in real time between persons for exploring subjects of interest</li> </ul>
Video conference	<ul style="list-style-type: none"> <li>• Complete simulation of a lesson</li> <li>• Complete simulation of a seminar discussion</li> </ul>

The table can be useful as a basis for an eventual agenda oriented towards defining a sustainable strategy for introducing technologies into a real university so as to extend it into virtual space. The advantages of a strategic choice oriented towards the integration between face-to-face educational activities and online activities have been emphasised several times (Bracewell et al., 1998). In particular, it is thought that aiming at a “mixed” model has positive implications on the learning processes and can in general improve the organisation of the “classroom” and of the learning activities (Harasim, 1997). It is also believed that the introduction of new technologies into a traditional context can facilitate

the circulation of information and the sharing of knowledge (Hiltz, 1997) and increase the level of involvement in various individuals, stimulating the development of new dynamics of interaction, reciprocal support and peer-to-peer help (Deden, 1998): this could increase the capacity for understanding the problems of the individuals who are learning (Anderson, 1997) and facilitate the processes of re-investment of the knowledge acquired by students in other contexts (Harasim, 1997). On the whole, it is a matter of options in which it is worth while investing resources.

### Towards e-learning

The scenario just described, although realistic and plausible, assumes that the identity of the traditional educational institutions is still strong or at least recognisable. In reality, according to other points of view, the diffusion of Internet and the growth of a capillary “online culture” are contributing to the opening of different horizons, in which not only the identity of the traditional institutions will tend to enter into crisis or be modified, but in which the weight of exclusively and typically virtual learning scenarios will become ever larger. The new scenario is indicated much more often with the term e-learning. Above all the new term aims at emphasising the ever closer relationship that is established between telematic technologies and education based on open and “distributed” models, without forgetting that there is emerging a fairly close link between online education and various economic/social demands. The term *e-learning* is thus destined to assume a wider meaning compared with the apparently equivalent online learning, with which the advanced experiences of online education are indicated. According to Elliot Masie, one of the first authors to explicitly use the new acronym<sup>2</sup>, inside this new meaning applications are found which come in part from the theories of open education and distributed education, in part from multimedia education, and in part from the new economy. Thus E, is not just electronic, as in the acronyms that have already entered into everyday language (e-commerce, e-business ...), but “digital culture” in the broad sense: “a very broad term which takes in more specific terms such as Online Learning, Computer Based Training, Web Based Training, Distance Learning and other similar definitions” (Masie, 2000). Masie furthermore speaks of e as experience, recalling the multiplicity of factors that contribute, or ought to contribute, to an ulterior evolution of the dynamics of teaching and learning as a result of the spread of the networks, or rather of online space:

- new ways of involving students (*engaged learning*);
- increase of curiosity and the desire to “explore”;
- possibility of simulating online situations with practical implications;

<sup>2</sup> Elliott Masie founded and directs *Tech Learn Trends*, a research centre dealing with the analysis of the trends in progress in the field of the relationship between technology and education. *Tech Learn Trends* organises seminars and workshops and publishes one of the newsletters on this subject that is most widely circulated via e-mail (on Internet, URL: <http://www.masie.com>). Elliott Masie’s research centre claimed authorship of the acronym in October 1999. Cf. *Newsletter Tech Learn Trends*, n. 147, 12 October 1999. On Internet, <http://www.techlearn.com>. The first international congress expressly dedicated to e-learning was organised from 12 to 15 November 2000. On Internet, <http://www.techlearn.com/congress/>

- development of forms of assisted education (*coaching*);
- growth of *peer tutoring*
- growth of educational activities linked to the real needs of the labour market;
- development of training practices to support the productivity of workers;
- increase in the need for “intensity” in educational experiences;
- possibility of guaranteeing students immediate feedback on their educational needs.

If in Masie’s vision e-learning is above all a set of opportunities, Janice Lawrence, President of Learning Solutions<sup>3</sup>, already speaks of it as a “system” which combines three elements considered fundamental in the perspective of the new economy:

1. The contents, or rather the necessity of continuously having available enriched and updated information, and consequently the instruments for elaborating, maintaining, organising, searching, selecting and setting the various aspects of knowledge, the databases and the educational materials in relation to each other.
2. The personalisation of access to contents, or rather the possibility for whoever is in the student’s position to concentrate, from a characteristically modular perspective, upon the solutions to their immediate educational requirements, above all where these are related to the need to define new professional profiles (to find a new position within the normal work context or to reply to a specific job request).
3. The connectivity, or rather the modality through which the individual student enters into contact with the “learning community”, in both a formal and informal way, is based on the assumption that most people prefer to dedicate themselves to the learning activity within the social context.

In this perspective, however much the economic factors are still in the foreground, the benefits of the expansion of *e-learning* are perceived within a broader framework which considers the general attributes of the “educational” system. Beyond the applications deriving from the new economy and the knowledge “market” which will probably characterise society in the near future, in the comments of Masie and Lawrence several trends which are more strictly relevant to the evolution of educational theories and to the assertion of a more constructionistic, open, flexible and distributed educational system can be recognised (Bracewell et al., 1998). The background upon which the new virtual learning spaces will be constructed is thus more complex than it appears at first glance. An integral part of it are certain widely-accepted postulates on the changes that the new tech-

---

<sup>3</sup> Learning Solutions is one of the leading companies in the production of platform software and services for education on the network. On Internet, <http://www.learningsolutions.com>. At present, through various mergers and purchases, the company is focusing on the activation of an e-learning gateway to be called THINQ. On Internet, <http://www.thinq.com>



nology and Internet are introducing into the educational scene. First of all, it is considered that Internet can guarantee an access that is more direct, interactive and open to information: it follows that the motivation for knowledge is increasing (Hiltz, 1997; Deden, 1998), that the learning experience is destined to become increasingly flexible, and that areas are being opened up for redesigning the modalities of education and professional updating in an ongoing and “performing” manner (Davies, 1997). In addition, thanks to the new technologies and the network, social interaction is recovering its importance in the learning processes: for example there is a trend to no longer consider negatively the difference between interactions mediated by technology and those in progress in real contexts. On the contrary, there are seen to be a number of implicit advantages to mediated interactions, including the possibility of defining more clearly the educational objectives and of activating forms of monitoring which are both more sophisticated and more flexible (Harasim, 1997).

The virtual communities supported by online technology are thus beginning to represent a model of a fairly widely accepted collaborative learning environment; this implies that it will be necessary to rethink the meaning of the term “classroom”, radically redefine the role of teacher, and focus more decisively on the active participation of students in the processes and on the individualisation of the curriculum.

The expectations, as can be seen, are both numerous and very attractive. However a more critical vision of the problem leads to the identification of some gaps in the process that is moving us towards the e-learning society. These include the difficulty of estimating the return on an investment, the tendential reluctance of companies and organisations to accept the idea of re-investing in a new educational project with strategic characteristics, the lack of precise wide-ranging strategies for integrating the educational offer, and the relative shortage of competent figures in the methodological aspects of online education. In addition, the absence of reliable strategies for integrating online education with traditional education can be noticed<sup>4</sup>, which in this scenario could run the risk of being considered “outdated”, forgetting that the network, in spite of its intrinsic potential, still conceals elements of “disturbance” for the learning processes, such as for example the two dynamic characteristics which Veltman (1994) called the “erosion of truth” and the “erosion of trust”. David Resnick (2000) even extends this observation to the social and political level, critically claiming that the affirmation of the Virtual University “simply reinforces market logic; it encourages students to invest time and money to create their individual human capital”. This means that there is a risk that education is increasingly considered a sort of “private good” and loses part of its significance as a phase in the training of a conscience oriented towards the involvement of individuals in civil society.

The success of *e-learning* and the consequent affirmation of the models of virtual learning environments in this sort of “globalisation” of education, is thus linked to the solution of a puzzle which is much more complicated than it seems at first sight. The very complexity of the “system” of online education is an integral part of the puzzle.

---

<sup>4</sup> See *Newsletter Tech Learn Trends*, no. 177, 26 July 2000. On Internet, URL: <http://www.techlearn.com>

The new society, which we might call the “society of distributed knowledge”, must provide an answer to closely related demands which involve both the educational offer – particularly linked to the need to train the skills required in the new economy – and the demand and “desire” for learning that online access can induce in an ever larger number of individuals. A very complex scenario is emerging, in which the distinctions between structured courses and the opportunities of learning in more informal ways in accordance with the 24-7 theorem will be increasingly blurred (Hall & Driscoll, 2000): a sort of “global learning experience”.

### **Models for a “virtual learning space”**

Both the scenario that focuses on the integration between real and virtual, and that which in principle accepts the idea that it is necessary to “re-invent” an organisation built around the needs created by the new forms of online learning, have repercussions on the most widespread models of “virtual learning space” (the term, *Virtual Learning Space* or *Virtual Learning Environment*, is probably from Linda Harasim). This does not mean that some models are only applicable in a given situation, for example the presence or absence of a traditional institution of reference. Rather it means that the formulations and reflections produced are based on two different assumptions, one closer to the idea that the *Virtual Learning Environment* must in some way correspond to a real and recognisable structure, the other more inclined to identify alternative solutions, generally founded on the interaction dynamics within the virtual communities.

Authors such as Harasim (1995), Turoff (1995) and Draves (2000) have focused on the structure and elaboration of patterns of “virtual learning space”, understood as the representation of a real and recognisable context, while others are more interested in defining a model to use for the development of an integrated platform for online education (Dwyer, 1995; Bilotta, 1998). These contributions particularly stress the idea that it is necessary to focus on a spatial metaphor that can reproduce or represent the social context in which we teach and learn, devoting different degrees of attention to the problem of the location and integrated management of the teaching resources, minor importance being attributed by those authors more interested in the educational process, greater by those aiming at an online education oriented towards contents, more in line with the demands of e-learning. Turoff’s original model (1995) even highlights the relations between the physical analogies present in the metaphor of virtual learning space and the levels of use of the corresponding technological infrastructure on the part of the protagonist. A typical spatial metaphor identifying a virtual learning space, partly derived from the model that Harasim elaborated for the implementation of the Virtual-U platform, partly from the *Virtual Classroom* defined by Turoff (1995), and partly from the LERN (*Learning Resources Network*) model elaborated by Draves (2000), comprises certain recurring elements.

- *An information office*, or the Web pages illustrating the features of the educational offer, an interactive space for promotion and contacts with the “cus-

- tomers”; the chance for the potentially interested student to contact an administrative office, or ask precise questions of organisers and managers.
- *The administrative office*, or an area where strictly administrative problems are solved, certificates of skills acquired are issued, and complaints and claims are presented.
  - *A hall*, where the complete catalogue of available courses can normally be consulted, experts and teachers contacted, and FAQs (answers to recurring problems derived from what has emerged in previous courses) analysed.
  - *A doakroom* or an area in which various individuals involved in the educational experience can meet so that they can get to know each other.
  - *A library* where teaching materials, Internet resources for consulting, articles, volumes for downloading and supplementary materials are stored and catalogued. The library is distinguished by one or more virtual spaces in which “resources” may be consulted, typically understood as the results of a process of knowledge management that involves the educational structure: FAQs on specific subjects, documentation of experiences already put into effect or other “grey literature”.
  - *A lecture hall*, or areas inside which part of the teaching activity is carried out, that is, in the form of conferences guided by tutors or attended by experts: in almost all models of Virtual Learning Space based on spatial metaphors this is the “heart” of the structure.
  - *A self-assessment centre*, or an area in which the students perform tests to assess their level of learning, not necessarily related to more official assessments of acquired knowledge aimed at certification.
  - *A workshop*, understood as a space for eventual simulations, where these are envisaged.
  - *A gallery* which the students can use, if they wish, to exhibit the work produced during their studies.

Many models also incorporate elements of recreation or of entertainment, or areas designed to give freer space to interaction, based on the assumption that – since learning develops in a social context – we must not overlook the aspects which contribute to make the context more pleasant or attractive, or to put the study activities in progress into perspective. In Harasim’s Virtual-U, for example, a “café” is already present. Trentin (1998 and 1999) also stresses on several occasions the importance of areas (in this case open discussion groups) where the students can meet each other without having to prepare a particular assignment or reach precise objectives. Draves (2000) even speaks of “cyber snack”, a recreational space where, among other things, films are projected. Finally, Turoff (1995) underlines the importance of the presence of play spaces in the virtual learning environment.



Fig.1. The home page of Virtual-U, an integrated platform for online education originally designed by Linda Harasim. As we can see, the virtual learning space is metaphorically associated with the representation of a real space, in this case a veritable university campus. It features the entertainment area (*café*), the library, the gallery to display work prepared by the students, as well as the normal areas for information and administration. Special focus is placed on the conferences, the laboratories and the course descriptions. Virtual-U is widely used as an infrastructure for the online activities of various traditional universities in both America and Canada. On the Internet, <http://www.vu.vlel.com>

It must be pointed out how, in almost all the models of the virtual learning environment based on the metaphor of the campus-space, the attention is constantly placed on the “functions” and on the modality of interaction between students and the components of the university: the structure of the traditional university tends to be reproduced, introducing exclusively virtual components. We can thus affirm that the spatial metaphor lends itself to application in cases where a real organisation begins to operate online, opening up to the integration between face-to-face activities and online activities. However, at the same time, the metaphor must also be interpreted as a manner of highlighting a new model or theory of organisation, in which, inevitably, we are obliged to make room for environments or roles that assume a specific meaning only in the virtual context. It is on the basis of these ulterior demands that the metaphor is modifying and expanding, eventually taking on the contours of an alternative model in which the association between administrative function and metaphorically recognisable space is increasingly tenuous. The first step in this direction is taken when, within a model rooted in the spatial metaphor,

there is a deliberate introduction of areas which have no strict connection with the educational institution evoked, and which have no correspondence to real or realistically verifiable situations. Generally, we are dealing here with areas that assume a specific meaning only in the virtual context, relating to characteristically online activities: rooms for open debate expressly defined as a chat rooms, rooms for permanent round tables and forums, specific “offices” for the professional figures that characterise the online learning scene: advisers, tutors, webmasters, operators specialised in database organisation.

The types of the virtual learning environments that move in a more oriented viewpoint towards e-learning are generally speaking more complex than the models just illustrated. In particular a certain attention is devoted to elements such as the modularity of the offer, and to the integration of various typically didactic areas and functions with others which contribute towards integrating the space into a larger communicative, social and economic context. Thus, in addition to the areas already mentioned, other elements, typically “virtual” and open to the new market of online education, are sometimes added: for example an area that we might call events centre, or pages and areas which make it possible to follow, often in real time, seminars, conferences, lessons and much else – in effect, “cultural sessions” which students can attend independently of the relevance of the subject treated to the courses followed. Then there is sometimes an e-Store – an area for the electronic sales of both teaching materials and consumer goods relevant to the interests of the student community – as well as a help desk for those who need advice about the educational offer in general in relation to the current trends in the job market, in effect a sort of paid advisory service. Some providers of educational services (learning portal) are even moving towards actual broadcasting, to back up the other available areas with spaces focused primarily on the provision of information in real time and of conferences, lessons or interviews in direct or in delayed transmission<sup>5</sup>.

The metaphor of the Virtual Learning Space is in continuous expansion. More specifically, it is moving towards overcoming the need to associate online operation and interaction with symbolic spaces. Whittington & Sclater (1998) imagine a model of the Virtual University that no longer recalls the campus or other recognisable structures.

The model extends over three “layers” or levels, that correspond, only ideally, to three floors of a building. The administrative elements are located on one floor, on the second the infrastructural aspects, and finally on the third floor the subject-matter elements, the didactic material, the true learning environment. The three floors correspond to the divisions in a system defined, not so much by the structure of the organisation responsible for the didactic activity and the related activities, as by the relations between the elements of the system itself. Sandelands (1998), citing among other things experiences of Virtual Universities launched to support corporate training activities, such as the English University for Industry, attempts to identify the characteristics of the interaction in progress between the various active components in the educational process. He comes to project the virtual learning space as a sort of diagram, the principal elements of which are,

---

<sup>5</sup> See for example Click2Learn (<http://www.click2learn.com>) and SmartForce (<http://www.smartforce.com>)

on one side the protagonists, on another the resources with which they interact, on yet another the context in which the interactions take place. On one side, the protagonists and individuals involved are identified.

The students, and more generally those who are interested in pursuing an educational course taking advantage of the opportunities offered by the virtual learning space. The teachers, tutors and all those who are involved in the direct output of education or in the support of online education under way. External experts and other individuals who can indirectly support the educational activities or who are interested in actively taking part in the educational scenario (for example observers from organisations which wish to assess the quality of education being pursued by the staff of the organisation itself).

On the other side the structure of the virtual learning space is represented as a set of three areas, which in part correspond to the same number of modes of interaction between the components operating within the context, and in part to a potential organisation of information and knowledge within the educational context itself.

The first area is that in which the actual courses are put into effect or in which educational material and structured courses are distributed. Typically, this area is conceived as a “storehouse” of modular courses (courseware), or as a set of “virtual classes”.

The second area presupposes the sharing of knowledge and the exchange of experiences among the various individuals involved in the process, in particular students and teachers (resources or knowledge base). Effectively, it appears as a set of shared resources, a sort of digital library with resources transversally usable in courses, largely produced by the components involved in the experience through collaborative interactions or activities, and continually in expansion on the basis of the requirements of the community.

Finally, the third area is the community which acts and measures itself within the virtual scene, understood as the community in its entirety – students, teachers, tutors, observers, experts. In practice, it is a social area, in which the components of the system are freer to measure themselves against each other. Effectively, the purpose of this com-

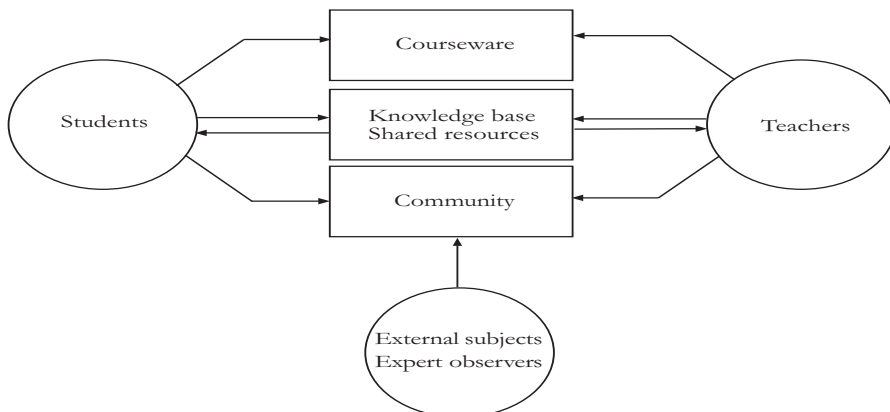

Fig. 2. This is a way of representing a model of the Virtual University which, instead of metaphorically indicating the symbolic spaces that correspond to the structure of an organisation, focuses instead on the relationships between the individuals involved and the areas of interaction between individuals: the *courseware*, the resources and the *knowledge base*, the community. The diagram is based on that of Sandelands (1998)

parison, whether declared or not, is to verify the results obtained and, above all, to point up the requirements and demands on the basis of which the educational offer will be constructed (or corrected) and the shared resources will be identified and produced.

It is interesting to observe the way some of the more widespread technological platforms for the management of online education have taken inspiration from this model<sup>6</sup>, used both in university contexts for dispensing part of the activities of traditional instruction online and on the part of the companies which are venturing into the market of *e-learning*. We can also assert that the model is linked to the development of the Virtual University in a strict sense – structures without traditional equivalents or which do not perform face-to-face activities – and to the need for simplification and modularisation of the educational offer of the portals which operate in the new global markets of *e-learning*.

### **The “virtual classroom”: reflections on a definition and comparison of models**

From the different metaphors that identify the “virtual learning space” comes the idea of the *Virtual Classroom*, that could thus, in one sense, be considered one of the environments of the *virtual learning space* or, sometimes, as one of its representations in a more defined and circumscribed context. In this sense, we can say that a “virtual classroom” is in every case a *virtual learning space*. Nevertheless, the overall perspective shifts, and attention must be focused not so much on the architecture of the space as on other elements and factors more closely related to the social nature of the environment, since it is a sphere for the confrontation between protagonists and for mediation between expectations, objectives, modalities of communication and of collaboration. Thus a *Virtual Classroom* cannot be simply defined “an online environment where all or part of the elements of interaction in a traditional classroom are simulated in the online environment” (Woodall, 1999). The moment we speak of online interaction, a new situation is mapped out which features its own specificity. The network appears, above all, as a territory of mediation, in which three fundamental relationships develop, or more often intersect:

- Student/educator;
- Student/student;
- Student/resources.

The concept of this division of online learning environments can also be found elsewhere (Riel, 1989; Driscoll, 1995), where the description of virtual classrooms points out how this particular space normally implicates the confrontation of three fundamental components:

- *people*, or the learning community as a whole (teachers, facilitators, organisations involved ...) but above all the interaction between students or between peers;
- *process*, or control over the educational course and the learning process, inevitably centred upon the relationship between tutors and students;

---

<sup>6</sup> The model has been used in an obvious manner on Blackboard (<http://www.blackboard.com>) but also in the structuring of the web sites of some large Virtual Universities, such as IMG University (<http://www.imguniversity.com>)

- *product*, or the result of the interaction between students and resources.

Ravitz (1995) suggests extending the breakdown to include at least a fourth element: the active and aware “participation” of components in the learning community, which can also be considered part of the process.

Nevertheless, such breakdowns – however useful they may appear in defining the problem – on closer observation may prove too rigid, difficult to apply in a uniform and univocal way to the online reality which is much more complex and flexible. The definition of *Virtual Classroom*<sup>7</sup> thus merits a much more careful examination, although as we shall see, in spite of a progressive convergence towards models with relatively uniform characteristics, there are still a number of different viewpoints and opinions on the subject. In particular, as observed in the analysis of the models on which the Virtual Universities are based, two distinct trends can be observed which sometimes proceed in parallel to the elaboration of a definition, while departing from different assumptions.

- On the one hand there is the tendency to link the definition of the *Virtual Classroom* models to the elaboration of a system, organisation or real technological infrastructure, the architecture of which metaphorically recalls the idea of (virtual) space inside which teaching and learning are found. Those who elaborate models starting from this assumption place particular attention on the components involved, and on the elements and phases in the teaching and learning process, as well as on the dispensing of teaching materials and resources. The focus of these researches is above all the structure of the virtual class, in its complexity and as an environment. The emphasis is above all on the planning and organising aspect.
- On the other hand, there is the tendency to define the virtual classroom primarily through the identification of the roles of the protagonists involved, and by analysing the modes of interaction in progress. In effect, departing from this second supposition, the virtual classroom is identified with the *virtual community* in a broad sense: the intangible online space is perceived above all as a territory of mediation, and therefore as a social space. The focus is on interaction and on communicative and collaborative dynamics; the virtual classroom is thus the set of problems triggered by what takes place within a network that is, primarily, a network of people. The emphasis is above all on the management aspect.

However much both trends presuppose a constructivist approach, it is not difficult to recognise in the first a fairly close relationship with the theories and the metaphors that have developed during recent years around the subject of distance education, online edu-

---

<sup>7</sup> We should recall that the term *Virtual Classroom* is also a registered trademark of the University of New Jersey. The trademark identifies both a specific model of virtual learning elaborated by Turoff and others since 1986 and an actual technological platform implemented to support that model



cation and the development of e-learning, while in the second case the most obvious connection is that with studies on *Computer Mediated Communication* and with the philosophies which inspire the theories of open and distributed education. The different philosophies influence the virtual representation of the classroom model and therefore the definition of the concept, while the classification of the models on the basis of interaction modalities seems to be transversal in relation to the point of view from which the virtual classroom phenomenology is observed, sometimes leading to a distinction between the asynchronous virtual classrooms, based primarily on interchange via e-mail, forums or *desktop conferencing systems*, and the synchronous, where there is more focus on chatting or on the use of instruments such as audio/visual conferences or shared blackboards.

### **Interaction in the social space of the virtual classroom**

On the more specific subject of the set of interactions which define a virtual classroom attention has been concentrated by Rowntree (1995), Andrusyszyn (1996), Bracewell (1998) and others – among whom, in particular, those who found inspiration in the “situated” learning theories of Collins et al., (1989). Warschauer (1997), in his turn, suggests that a virtual learning environment is made up of the sum of “situated” interactions in progress between online students at the moment that, through the mediation of technology, they establish forms of dialogue that imply positive benefits for the educational course. A virtual classroom is thus a social space. But how are the relationship dynamics between the various individuals who operate inside this space modified?

According to Rowntree (1995) many online teaching and learning experiences emphasise a double model of interaction: on the one hand tending to favour the active participation of the individual student, focusing on his/her interaction with resources and materials, variously assisted by a tutor; on the other hand tending, on the contrary, to emphasise the reciprocal help that is hopefully triggered when the experience focuses on collaborative learning or, more simply, tends to indicate a work group that can be defined as *self-help*. It is the combination of these two moments that, beyond any metaphor, contributes to defining the virtual learning space. However, Rowntree himself admits that the emphasis on these two models, both “extreme” in their own way, does not take into account the necessary flexibility of a “virtual classroom”. In almost all experiences the typology of interaction tends to be mixed, featuring the co-existence of both interactions between individuals (student-tutor) and the one-many or many-many interactions typical, for example, of the *desktop conferencing* environment. Thus to understand how to move in a virtual classroom, we must not forget that, even when the online course is prevalently based on the use of material structured or thought out for individual use, the eventual public reaction of the student regarding the study of the material itself is an integral part of the course and constitutes a part of the body of knowledge tackled by the online educational experience. Accepting the hypothesis that the network tends to amplify the collaborative dimension, the reciprocal tutoring strategies and the diversification of the active roles in the learning “space”, macroscopic differences between the traditional class and *Virtual Classroom* can be highlighted. In the traditional classroom the scheme of relationships that

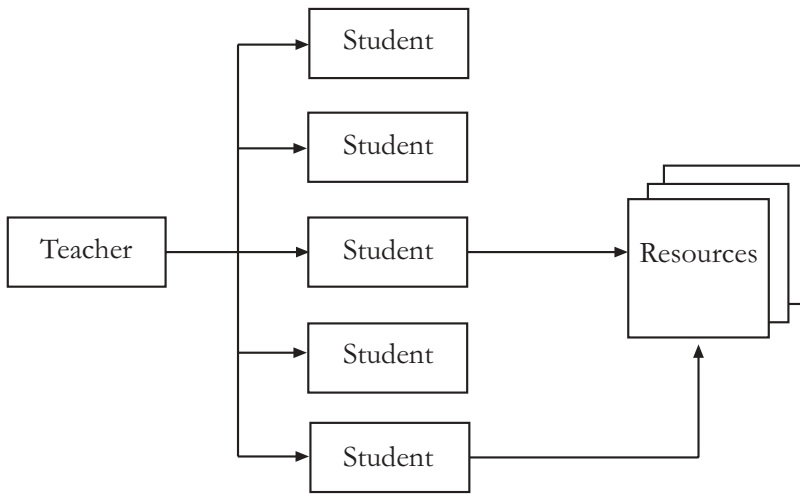

Fig. 3. Diagram of interactions in progress in a traditional classroom.

develop between the protagonists involved tends to place the figure of the teacher in the centre of the stage, while the access to the resources appears as prevalently individual.

In the virtual classroom, on the contrary, the centre stage is constantly occupied by all the students and by the interactions in progress inside the learning group. Other interactions are established with a multiplicity of other figures, each one of which enters into a relationship with the classroom either in direct or indirect form, through the mediation of communication technologies or of resources used in the process, establishing dynamic

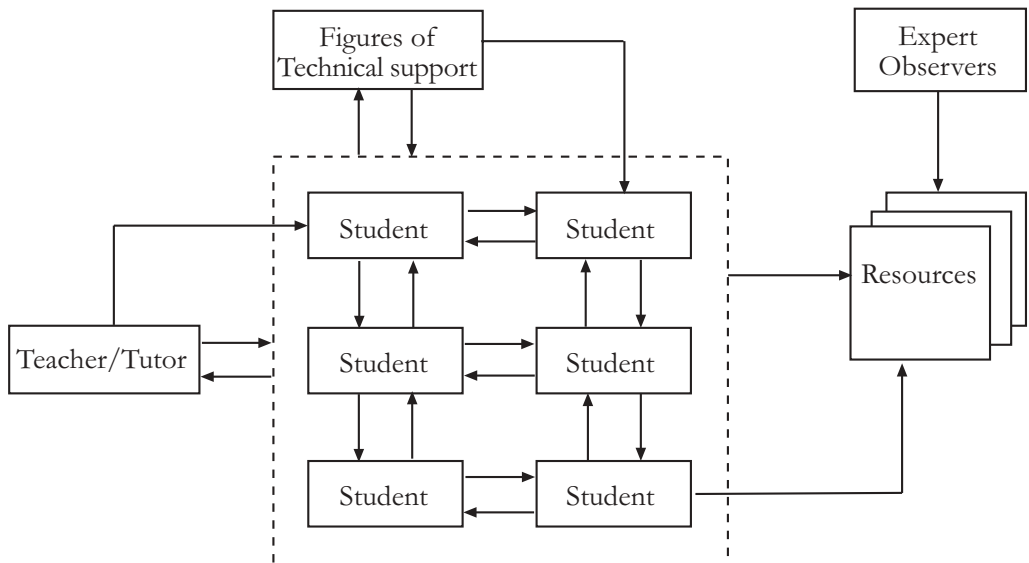

Fig. 4. Diagram of interactions in progress in a virtual classroom.

relationships either with the whole group or with single components. Altogether, the scenario appears more open and flexible.

An approach that is more oriented towards the structuring and planning aspect, towards the training and supplying of teaching materials, sees the virtual classroom above all as an “environment”, necessarily attributing a certain importance to the criteria through which the students select resources and to the support and organisation of the system. An approach more oriented towards interaction and towards activation of collaborative dynamics will aim instead at other elements and will tend, not so much to produce metaphors for contextualising teaching and learning activities in a hypothetical space, albeit virtual, but at concentrating upon the management of relationships between the protagonists and upon the techniques to be developed for increasing co-operation and partnership. We can also observe that there is a relationship between the model of virtual learning space and the technological infrastructure used for equipping the virtual classroom. In a *Virtual Classroom*, in which a certain importance is given to shared resources and to operating, one must aim at a platform or at a specific solution. If instead one wishes to emphasise primarily the aspects linked to interactions and to relationship dynamics, one can select a more “graduated” solution, without placing particular emphasis on the technology itself, attempting to use various simple technologies, particularly those for interpersonal communication, in a gradual, limited or transparent manner. According to Mary-Anne Andrusyszyn (1996) the *Virtual Learning Space* should in this sense be perceived exclusively as social space: the focus is on “community spirit”, to the extent that, in the eventuality that one intends to proceed to the implementation of a specific technological solution – continues Andrusyszyn – one must above all consider “an area for participants to introduce themselves, one for asking questions related to the technology, another for assignment discussions, and even one for sharing relevant readings that participants may have found.”. The imagined solution is in substance based on one or more forums and not on particularly complex platforms. What changes, however, is the role of those involved and the way of managing different solutions (Bracewell, 1998):

	<i>Increasingly less...</i>	<i>Increasingly more...</i>
<i>Teacher</i>	... transmitter of knowledge	... facilitator
<i>Learner</i>	... limited access to the resources	... assisted access to resources
<i>Contents</i>	... pre-organised	... constructed in collaboration
<i>Context</i>	... limited support	... extensive support

A conclusive comment on the various models of the *Virtual Classroom* that have thus been defined leads one to consider that many of the dynamics of the traditional classroom cannot be reproduced and simulated online, for various reasons. Firstly, distinct differences emerge in the interaction between components in the learning environment of a real and a virtual classroom; these can be summarised in the following table.

TYPE OF INTERACTION	IN THE REAL CLASSROOM	IN THE VIRTUAL CLASSROOM
Student/educator	<ul style="list-style-type: none"> <li>• The interaction is prevalently synchronous</li> <li>• The form of interaction is prevalently that of the lesson</li> </ul>	<ul style="list-style-type: none"> <li>• The interaction is prevalently asynchronous</li> <li>• The form of interaction is prevalently the use of distributed resources</li> </ul>
Student/student	<ul style="list-style-type: none"> <li>• The interaction is prevalently synchronous</li> <li>• The "learning group" is almost always homogenous</li> </ul>	<ul style="list-style-type: none"> <li>• The interaction is prevalently asynchronous</li> <li>• The "learning group" is rarely homogenous</li> </ul>
Student/resources	<ul style="list-style-type: none"> <li>• The resources used are prevalently analogical and almost always "closed" (books, CD-ROMs...)</li> <li>• The access to the resources implies the solution to logistic problems (access to premises, opening hours...)</li> </ul>	<ul style="list-style-type: none"> <li>• The resources used are prevalently digital and generally "open" (Internet sites, Forums...)</li> <li>• Access to the resources is facilitated by the possibility of operating independently of space and time</li> </ul>

Secondly, in virtue of these very differences, due largely to the fact that one is working in a context that maintains an extremely flexible link with the space and time co-ordinates to which one is more accustomed, it is inevitable that in a virtual classroom specific problems emerge, which regard above all the sustainability of the learning process in this particular context. Beyond the model that one intends to apply, one must then identify the criteria for analysing what happens in the online learning space and, consequently, for understanding how to deal with difficulties, solve critical problems and facilitate the achievement of established objectives.

**The difficulties of "students" in a virtual classroom**

For a better understanding of what happens inside a "virtual classroom", we can start from a formal representation which highlights the ways and the times through which students acquire the necessary competencies and skills for the learning community to be considered fully operative. The diagram is inspired by the learning curve defined by Rowntree (1995), with the addition of the time variable.

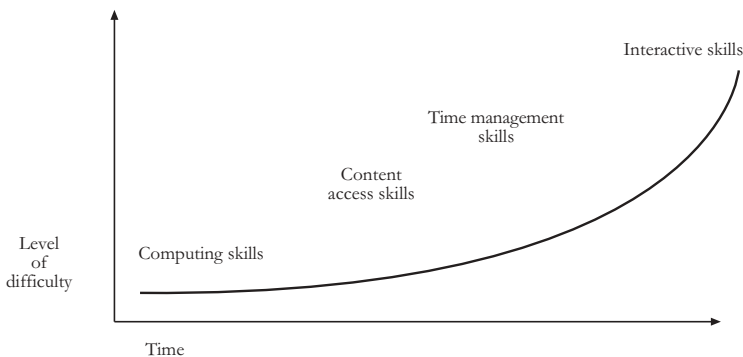

Fig. 5. Ways and times to become fully operative

Four large areas of skills and competencies can be identified, according to a crescendo of difficulty that inevitably implies an acquisition deferred in time by the students. As a rule (and contrary to what is commonly thought) the computing competencies are those which are learned more rapidly and more easily: particular efforts are not necessary to become familiar with the browser and with e-mail, nor with other potentially selected tools, unless these are particularly complex. In any case the acquisition of the set of basic computing skills for putting into operation the online education experience is preliminary to any other objective, and tends to inevitably pass into the foreground and be rapidly solved. At a subsequent stage, and on a plane of relatively higher difficulty, come the skills needed for the access to and understanding of contents. Clearly we are referring to the contents supplied and distributed using the online communication techniques and the sharing environments eventually envisaged in the definition of the technological infrastructure of the course. The main difficulty that students in a virtual classroom encounter in this phase, therefore, relates not so much to the understanding of the contents themselves, as to the way these are provided: in fact frequently students who participate in an online education experience, however familiar they may be with the subject dealt with in the course, are accustomed to using only media of the textual type (Rowntree, 1995) and can feel uncomfortable about consulting hypertextual and multimedia resources, or when faced by a particular “form” of electronic message, either asynchronous or synchronous. From this moment on the difficulties increase, and the other skills necessary for the learning community to consider itself operative will take even longer to acquire. The students will learn, not without a certain difficulty, to manage time, or rather to make and follow certain rules for maintaining a constant and profitable relationship with a learning environment that, in view of its very flexibility, could result dispersive in the absence of the capacity for self-control. They will also eventually learn to interact with other components of the virtual community, an objective among the most difficult to reach and, it must be said, not always achieved by those who participate in online education experiences, with the result that it could be considered a discriminating factor for determining success or failure in a course. To better understand the sense of the “curve” we can summarise the specific objectives of each area of ability in a more detailed table.

LEVEL I	LEVEL II	LEVEL III	LEVEL IV
Computing skills <i>Means at least...</i> <ul style="list-style-type: none"> <li>• Knowing how to use a browser</li> <li>• Knowing how to use e-mail</li> <li>• Knowing how to use a Web forum</li> <li>• Knowing how to use an integrated environment of desktop conferencing</li> </ul>	Contents access skills <ul style="list-style-type: none"> <li>• Knowing how to consult hypertextual resources</li> <li>• Knowing how to move in a multimedia environment</li> <li>• Succeeding in correctly interpreting contents produced by others in the absence of face-to-face confrontation</li> </ul>	Time management skills <ul style="list-style-type: none"> <li>• Regularly checking the e-mail</li> <li>• Planning forum consultation</li> <li>• Regularly verifying the evolution of a shared project</li> <li>• Completing assignments within set times and respecting deadlines</li> </ul>	Interactive skills <ul style="list-style-type: none"> <li>• Respecting the rules of netiquette</li> <li>• Learning and sharing elaborated resources</li> <li>• Learning to collaborate with others for solving a common problem</li> <li>• Knowing how to encourage other components of the group</li> <li>• Knowing how to modify attitude in an online discussion</li> </ul>

It is clear that the time factor and the ability for solving the difficulties of the case can vary considerably from one person to another, both in relation to the learning styles of each, and because within a group of online students there may be individuals who have already matured experience in online activity, for example by participating in a discussion group. It is likewise evident that the acquisition of the set of basic skills depends on how the online education experience was planned and on how and when the tutors and the other individuals involved in the process are able to respond to this sum of educational needs.

The theoretical structure presented above finds extensive confirmation both in literature and in practice. According to Kearsley (1997), in the virtual classroom difficulties can emerge through prejudices that sometimes direct the actions both of students and of tutors or experts. It is believed, for example, that to participate in an online learning experience one must be expert in the use of technology, that in a virtual classroom the effective study activity is less than that of a real classroom or, on the contrary, that it is difficult to find the time necessary for doing required activities and that online interaction is cold and impersonal. In substance, the same problematic areas pointed out by Rowntree are mentioned. Further confirmation that students learn to move in a virtual classroom by means of a series of *steps* which start from the familiarisation with technology progressively building up to the ability to actively participate in discussions and collaborative activities is found in Salmon (1998). On the basis of experiments conducted for the Open University, the author explains how the students first came to understand how the technological infrastructure worked, moving on, respectively, to socialisation, knowledge-sharing, knowledge construction and to the skill of moderating in turn online discussions and activities on the network. There are evident analogies between this interpretation and the pyramid scheme through which Trentin (1998) illustrated the possible uses of telematic technologies for educational purposes. Even the psychologists (Wallace, 1999, pp. 77-95), analysing the common "errors" verifiable in the interactions in progress within a virtual community (above all via forums or mailing-lists), notice a characteristic sequence in the typology of errors: starting from the incorrect or inexpert use of technology and from the so-called "band width waste" (useless showy decorations, superfluous overload in proportion to the message), through typically online violations of convention (including spamming), up to come to the violation of specific conventions established by the reference community – including the use of improper language inside messages – or to violations of an ethical character, such as the distribution of e-mail addresses without the consent of the interested parties or the diffusion of personal information relating to other individuals, these last points being indicative of non-acquisition of the ability to interact with the group.

The various types of difficulties pointed out more or less consciously by online students represent many areas upon which it is necessary to carry out a critical reflection, within the more general problem of the practicability and of the sustainability of online education experiences. Sometimes these same problems are the object of analysis and specific studies. Berge (1995), for example, speaking of the activity of *facilitator*, points out how he had the task of actively intervening on at least four levels:

- technological;
- pedagogical;
- social;
- organisational/managerial.

The levels identified by Berge as fields of action for online tutors correspond substantially to the areas which are the subject of this critical reflection itself. We can thus reasonably claim that in a virtual classroom these are problematic situations that require greater attention, and upon which the activities of the tutor or that of other individuals who are part of the team of educators or organisers of the experience must be focused. Some of the specific problems of each critical area can be summarised.

The difficulties linked to the students' lack of computer experience or familiarity with the software instruments are common in virtual classrooms. This aspect is often undervalued: in reality the skill of the whole group which is learning to move with relative confidence within the technological platform used plays an important role in determining a profitable climate within the "virtual classroom". It must be said that sometimes students who are not very motivated tend to conceal other types of problem – and occasionally the deliberate desire to not participate – behind the alibi of technical difficulties (Gilbert, 1997). In any case, intervening to fill the technological gap is one of the first "missions" to be accomplished to guarantee the success of an online course. The learning curve traced by Rowntree demonstrates that, among the critical situations, the students' familiarisation with technologies is that which can be more easily and rapidly resolved. Effectively, recycling various ideas of Berge (1995), and also inspired by Harasim, Feenberg and others, we can schematically give some useful suggestions for tackling the problem and improving the overall climate of the virtual learning environment.

- Adopt a technological platform which, while answering the needs of the course, also proves technically reliable, is easily used and is rapid and efficient: a sensible choice does not resolve all technical problems, but can facilitate their solution.
- Verify in advance the level of students' familiarity with telematic and computer technologies in general and, in particular, with the technologies adopted in the course.
- Set up a technical support, both in the form of referees to whom the students can turn in case of difficulty (Berge, 1995) and in the form of guides or textbooks, preferably synthetic, on the features and functions of the instruments used.
- Guarantee sufficient time for the less expert students to acquire basic skills, arranging familiarisation phases and opportune moments of testing.
- Facilitate forms of *peer tutoring* immediately, seeking to stimulate the technically more skilled students to help the more uncertain ones.

More specifically, as regards the difficulties in accessing and understanding contents, there is a tendency to consider (Woodall, 1999) that it is primarily essential to tackle some typical problems of the virtual classroom. In particular:

- the difficulty or the impossibility of the tutor to verify in an immediate or intuitive way the level of students' interest in the material or the effective use of assigned resources on the part of the students themselves;
- the sense of passivity that online resources sometimes produce in students (in comparison to the presumed sense of satisfaction or involvement that instead a materially perceptible resource, such as a book, produces).

The tutor therefore continually encounters a series of risks: in particular those of: failing to sufficiently clarify assigned tasks, the routes to be developed or the strategies to follow; failing to transmit "enthusiasm" to the students; not knowing exactly whether, and to what extent, students have followed his/her suggestions and at what pace; failing to produce, re-elaborate or locate material and resources capable of involving the whole "class" while respecting individual learning styles. On the contrary, students, who are accustomed to the real learning context, communication that is immediate and supported by a paraverbal and sensitive apparatus which makes it rich and clear (at least apparently), and to the characteristic question-answer dynamics, generally tend to feel that face-to-face activity is more productive and more effective than online activity (Berge & Collins, 1995) and that the contents supplied online are more difficult to manage and assimilate. It can also happen that those who are accustomed to face-to-face education feel a characteristic sense of online contents overload (Turoff, 1995; Harasim, 1997), a form of stress that has sometimes been defined as a sense of frustration (Hara & Kling, 1999) or more wittily, "discomfort" (Stathakos & Davie, 2000). We can intervene on these levels of difficulty, seeking above all to highlight the advantages of online as regards the management and distribution of subject-matter:

- it could be useful to remind participants of an online course that everything produced, including the complete documentation of all discussions between the active subjects of the virtual classroom, is digital material which is memorised and thus easily reusable;
- it should always be stressed that it is possible online to create an interface between many interlocutors who are unlikely to be physically available in one place: tutors and experts on the subject being dealt with, and with whom it is possible to exchange views on a problem, resource advisers;
- we should try to stimulate a correct spirit of shared knowledge among the components of the virtual classroom (Schutte, 1996) and facilitate *peer tutoring* as a strategy for dealing with contents.

The problem of the relationship between "students" and learning times emerges with constant regularity, because online education is often education aimed at working adults.



Thus the problem involves the compatibility between the student's normal activity and that which he/she is called upon to perform online. Masie (1997) considers that most experiences of online education are too long and that the courses proposed should be more compact and modular so that students can follow them without their studies becoming incompatible with their work. The planners of online courses aim, instead, at various strategies for facilitating students in managing the time they intend (or are able) to dedicate to online activities. One solution consists in attempting to make online courses "sustainable". In this respect, many experts (Berge & Collins, 1995; Harasim, 1995; Andrusyszyn, 1996) consider that, in activities of a collaborative nature, the observance of a series of rules and restrictions is a necessary condition for obtaining a profitable result. It is recommended that the moderators and tutors:

- establish precise deadlines;
- verify that students respect the hand-in date by intervening in person to request the completion of an assignment or the finalisation of a discussion within the established date;
- define precise rules of netiquette for respecting time limits and illustrate them to students;
- guarantee a constant visibility of the process, so that students perceive the presence of the tutor and the other figures as a constant over time.

In reality, this set of recommendations envisages an optimal *performance*, that can be verified only in conditions of excellence. In the majority of the cases non-compliance with a deadline is not due to the student's non-fulfilment or to the tutor's scanty attention to the process; rather it is connected to a poor degree of compatibility between the type and mode of the activities that should be developed online and the contingent situation of the individual subject involved. Elliott Masie suggests we should always aim at *synthesis*, *practicality*, and *modularity*, three factors that can determine the success or otherwise of the online educational offer. We can therefore guarantee the sustainability of an online activity, above all when it is of a collaborative nature, if and when we identify (and achieve) over time the partial objectives – possibly in relation to a broader final objective which takes in all that has been done up to that moment. A feasible alternative is represented by the development of more informal educational courses, where rather than creating restrictions, a greater freedom is given to the student in terms of times and modes of learning. It is clear that, in this case, managing collaborative activities becomes more difficult without the intervention of a co-ordinating figure who can be responsible for the process in the long term.

Finally, it is thought that the principal cause of the difficulties of interaction among the protagonists present in a virtual classroom is linked to the communication *overload*. In fact, the number of messages often grows out of all proportion, until it becomes intolerable both for students called upon to interact and for teachers and tutors. There are a number of normally identified causes which can, directly or indirectly, lead to situations of communicative *overload*.

- The need to know each other better: in many virtual classrooms students do not know each other but wish very much to do so: for this reason they begin to use the mailing-list or the forum that they have at their disposal to introduce themselves or make themselves conspicuous.
- The presence of disturbing elements in a discussion group, for example individuals who have not yet assimilated the rules of *netiquette* or who allow themselves to be swept away by enthusiasm for a medium they do not yet know.
- The tendency of using to a greater extent the simpler and more intuitive instruments among those available even for operations for which the organisers of the online course have set up special environments: e-mail, for example, sometimes distinctly has the upper hand over the other elements of the infrastructure (Rotta, 1997).

None of the causes indicated presupposes an error of formulation at the beginning: that the participants of an online experience want to know and communicate with each other as humans is comprehensible, as indeed are the desire to make oneself conspicuous and the tendency to use the simpler instruments among those available. One can intervene to keep these situations under control by aiming at either a “tactical” approach or a more strategic one. A typical tactical approach consists in considering the communicative difficulties and distortions as a fact, and thus accepting their inevitable presence, while limiting the negative effects as much as possible: in many models of virtual classroom, for example, the students are given specific areas of freedom, free areas for chatting or meeting in “forum-café”. These areas, over which tutors, teachers and moderators do not exercise any control, serve to focus the desire to communicate or the latent exhibitionism of single individuals, at the same time indicating the need for other moments which are more formal and subject to restrictions. The strategic approach, instead, is founded on the sustainability pre-requisites of the entire system: it aims in particular at establishing a very rigorous netiquette, making sure that tutors, teachers and moderators are equipped with the necessary instruments to ensure it is respected. It also attempts to make a very precise definition of the figures of the various individuals involved in the experience, in particular the figure of the tutor, carefully selecting the persons who correspond to the outlined profile and who should thus be best equipped to manage the situations they will encounter. In reality, the problem involves a much larger field: it is a question of understanding what one can do to make interaction among all the individuals who meet in the virtual space of an online classroom effective and profitable. It is thus a question of understanding in what way interactions can be analysed and evaluated and, more in general, of taking into careful consideration certain variables without which any analysis risks proving abstract. Let us consider certain facets of the problem in greater detail.

### **Criteria and models for the analysis of interactions in a virtual classroom**

The management of interaction between the components of a virtual classroom can be facilitated by a good analysis of what is happening. Literature on the analysis of inter-

action within online discussion and learning groups is relatively vast. Various approaches are distinguished, in particular the tendency to take into account quantitative variables (through which we can obtain useful information about how to make the activity more sustainable) and the tendency to consider exclusively qualitative parameters or those oriented towards the interpretation of the contents of the interaction. There are necessarily differences, even between the criteria adopted to analyse the interactions in the asynchronous environment and those used to evaluate what happens in a synchronous discussion.

### *Analysis of asynchronous interactions*

The most diffuse models for the analysis of interactions in asynchronous discussion groups, whether they are based on the use of a mailing-list, or supported by a Web forum or integrated platforms, usually examine parameters of both the quantitative and structural type. Substantially, the quantification of interactions is not an end in itself or dictated by pure statistical necessity, but generally oriented towards highlighting the progress or thread of the conversation: thus it should allow the identification of eventual critical moments and weak points, helping the tutor, moderators or other figures to intervene with suitable contributions, adjustments and incentives. Some instruments for the analysis of interactions in asynchronous discussions of this type have already been suggested and experimented during the first experiences of Online Learning at the OISE (Ontario Institute for Studies in Education; cf Harasim, 1989). The models for the analysis of discussion threads have been successively refined or variously modified, in particular by Simoff (1999 and 2000), who suggests formally representing online interaction (the term used is interaction in “asynchronous seminars”) as a tree with ramifications and still further ramifications, so as to highlight the relationships existing between the various messages and the interdependence of the various contributions, both in accordance with a logical hierarchy and, sometimes, by introducing the time factor, that is, measuring the importance over time of references to a subject of discussion triggered by an original message. Schematically, analyses of this type produce a representation of the interactions taking place in discussion groups activated in a virtual classroom, as below<sup>8</sup>:

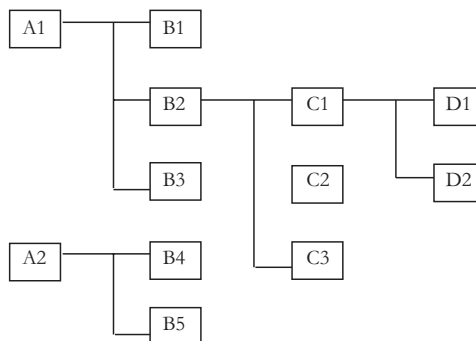

Fig. 6.

<sup>8</sup> The diagram is only indicative. There is also software which enables the reconstruction of diagrams of trees on the progress of an online conversation analysing the texts of e-mails and locating, thanks to artificial intelligence engines, repetitive and analogous textual occurrences of various kinds. One such software is *TextAnalyst*, cited as an example by Simoff himself. On the Internet, <http://www.megaputer.com>

E-mail A1 provokes 3 replies from as many interlocutors, some of which in their turn trigger other replies, until the discussion thread can be considered concluded. In the same way, e-mail A2 produces replies, which can in turn induce ulterior reactions. These formal representations of asynchronous discussions can be obtained on the basis of various indicators. In the analysis of the progress of a mailing-list conversation objective parameters can be taken into consideration, such as the use of the function of reply, or the more thorough analysis of e-mails from the contents aspect in order to set them in relation. Effectively, the tree that formally represents the development of the discussion is reconstructed by analysing various factors.

In the forums or in the area forums of many integrated platforms one is instead assisted by the system itself, which immediately highlights the structure of the discussion, since each contribution is necessarily inserted inside its own thread, being “posted” by its author as the principal e-mail within a topic or as a reply to a given message situated on any branch of the structure. This does not mean that it is not necessary, if one wishes to make a particularly thorough analysis, to also take contents into consideration, so as to trace out the real progress of the discussion beyond the apparent one: it is in fact clear that an e-mail inserted in the forum as a reply to another could in reality contain significant references and links to other e-mails related to other discussions in progress. The progress of the discussion can thus be represented starting from various types of analysis, for example taking into consideration two factors that Simoff (2000) himself calls “weight of link” and “weight of term”: the first factor implies a direct link between e-mails, and a structure usually very close to the interface of an online forum; the second factor can contribute to setting in relation even apparently quite unrelated e-mails, and to defining a new structure, sometimes much more articulated and complex. On the other hand the interpretation of the resulting model appears more problematical: is it sufficient to conceptually formalise how a discussion developed in order to understand what happened? Perhaps the more useful elements are those linked to the verification of the depth and width of the discussion. Simoff (in Jones, 1999, pp. 46-47) calls “reference depth” the number of references induced from an e-mail in a logical sequence. Instead he calls “reference width” the number of replies referred directly to an e-mail and “reference height” the relationship between the e-mail and the thread in which it is inserted. For example, calculating the overall number of e-mails which have been stimulated and triggered by one original message, right up to the last ramification (discussion depth), helps one to understand the interest generated by the subject of the debate and if and to what extent the discussion itself was articulated and constructive. Calculating instead how many direct replies were produced by a given e-mail (thickness or “reference width”) in relation, for example, to the number of persons registered in the discussion, the impact of the e-mail can be highlighted in relation to the “sense” of the community and its capacity to trigger moments of sharing directed towards a collaborative knowledge construction.

The models of analysis of the thread cannot neglect a more thorough analysis of the effective contribution of the single individuals active in the virtual classroom.

The analyses conducted on the online courses of the Open University<sup>9</sup> follow a precise method in gathering quantitative data. The variables considered are at least five:

1. Total number of e-mails (useful for evaluating the level of participation in general).
2. Number of e-mails sent by students in relation to the number of e-mails sent by tutors (useful for evaluating the level of active participation by students).
3. Number of e-mails produced by students (useful for verifying the presence of more or less active students within the virtual classroom).
4. Number of e-mails produced in a given time span (useful for evaluating the progress of the students' participation level).
5. Length of e-mails in relation to a given time span (helpful for understanding if an eventual qualitative increase in contribution is in progress or if there is a lowering of interest level).

The quality of interaction, on the other hand, is determined by means of the specific analysis of the e-mail contents so as to understand whether they refer to the educational course, to other interests or if they are independent contributions, or messages with a social/emotional motivation. A methodology of this type, called IRA (Inter-message Reference Analysis), was developed by Levin, Kim, and Riel in 1989. Starting from an analysis of the references in each e-mail to the preceding ones, the method makes it possible to trace out a contribution map graphically illustrating the links and connections between one e-mail and another, providing a sort of "gauge" of the level of interaction in progress within the virtual classroom. In the model used at the Open University, the e-mails are classified in various categories on the basis of contents.

- E-mails that refer to personal experiences or of an emotional or sentimental nature.
- E-mails that refer to informative material or requests for information.
- E-mails that attempt to propose new problems and open questions.
- E-mails that synthesise the discussion.
- E-mails that propose new subjects for discussion.

The comparative analysis of the tables resulting from the decoding of e-mails can help determine the overall quality of the interactions in progress. The methodology of the analysis of interactions adopted in the Polaris project (Trentin, 1999) can be considered similar. In this case the elements considered in the analysis of the e-mails between students are the number of contributions produced by the individual students, the degree and features of the interactivity of the contributions themselves, the level of "coverage" of the subjects under discussion (pertinence of the contributions), the level of "thorough

---

<sup>9</sup> On Internet, <http://www.open.co.uk>

examination” of the subjects under discussion (granularity of the contributions). Certainly, analysing the e-mails produced during an interaction from the viewpoint of type and contents can be anything but simple, given the often fragmentary nature of online communication and the frequency in e-mails of commingling, cross-references, and multiple quotations. Fafchamps (in Mason, 1998) tries to classify the contributions of the participants in a group discussion in three broad categories: “islands”, or e-mails which do not refer in particular to others that preceded them and which in turn do not produce replies; “dialogues”: small sets of two or more e-mails closely linked to the same subject; and “webs”: sets of different e-mails linking and intersecting with one another. More concretely, Simoff (in Jones, 1999, pp. 48-51) introduces ulterior elements of qualitative analysis, proposing a grid based on three forms of categorisation of the discussion contents. The first categorisation relates to the “dimension” of the discussion, identifying five salient attitudes:

- “Issues: the topics to be discussed and resolved;
- Leadership: the inclination to conform with or reject leadership and authority;
- Debate: argumentativeness, criticism, or aggression among participants;
- Relationships: expressions or avoidance of friendship or intimacy among participants;
- Action: goal-directed or task-directed activity”.

A second categorisation focuses on locating the characteristics of communication management itself, in particular distinguishing formal from informal communication.

A third categorisation deals with the problem of contents and of the “slant” of the e-mails in a strict sense, identifying a number of characteristic communicative typologies:

- socio-emotional;
- conceptual;
- task oriented.

The author suggests analysing the evolution of a virtual community over time by means of this grid, so as to try to effectively understand what is happening, beyond the statistical considerations or the hermeneutic efforts: What attitudes prevail? What are the trends? What type of *communication management* is being established?

Starting from similar assumptions, in the end other models try to represent, not so much the progress of the discussion, as the flow of the interactions in progress within the virtual network space between the protagonists who are taking part. These models, widely used for analysing the relational dynamics with social implications inside the network, or for highlighting how the relationships between the components of an organisation are modified in the presence of different communicative infrastructures (Garton and others, in Jones, 1999, pp. 75-100), are based on the decoding of contents in the e-mails and on the graphic visualisation of the web of relationships that the different types of contents allow one to deduce.

Effectively, we attempt to see not how much or what is communicated, but who communicates with whom, so as to understand if it is effectively proceeding towards the constitution of a true “network” or if, on the contrary, social dynamics which are still relatively hierarchical are being re-proposed. For example, analysing the communicative flow in process in the initial phase of an online educational activity in which various individuals participate, a diagram similar to the one reproduced below could emerge.

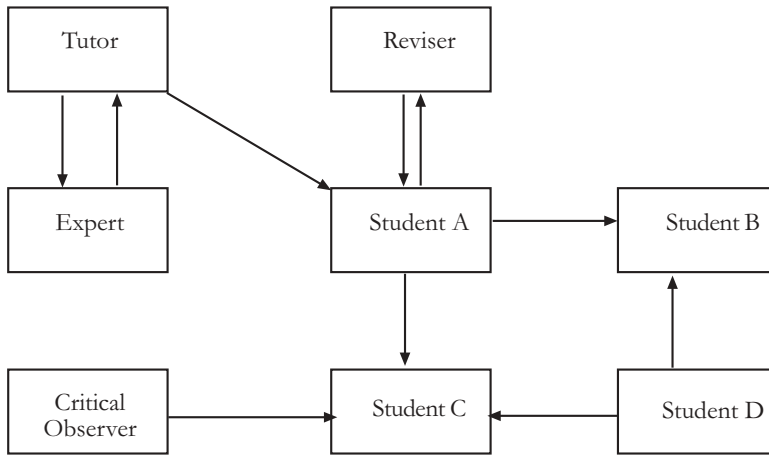

Fig. 7. Communicative flow in process in the initial phase of an online educational activity

In this case, the communication flow still appears to be fairly closely based on hierarchical assumptions: there is insufficient interaction, and it is not carried out in a dynamic way. One must thus try to intervene to stimulate more complex and articulated relationships. Analysing the situation again after a certain period of time, one could thus verify in what way and how much the situation has changed. A new analysis of communicative flows in progress could produce the following results.

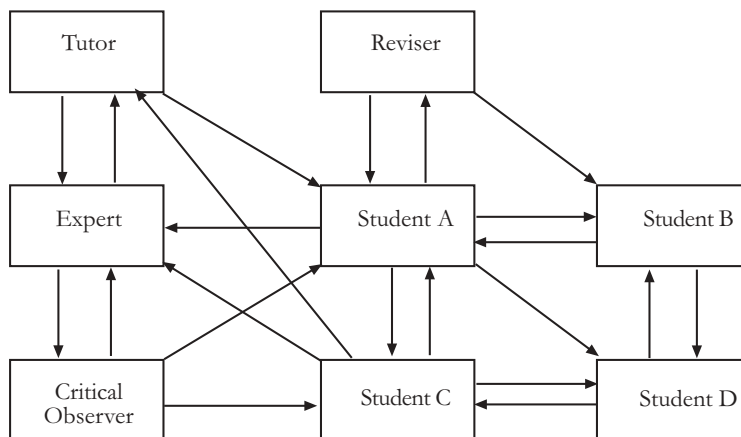

Fig. 8. Communicative flow with complex and articulated relationships

The mesh in the network has become more dense, the hierarchical bonds between the protagonists are less evident. This can mean that a good job has been done and that the virtual classroom that is configured by the network is provided with a propulsive force, with a capacity for generating positive results. Obviously, it is assumed that the creation of a very dense social network constitutes added value in an educational experience and generates a positive resolution in terms of learning quality. These models necessarily presuppose the presence of a complete monitoring system or the possibility of integrally analysing the interaction among the protagonists. In educational experiences that are not exclusively based on integrated platforms (for example in courses where extensive use is made of simple electronic mail) it is clear that a part of the dynamic relationships can pass unnoticed by whoever has the duty of monitoring the interactions.

#### *Analysis of synchronous interactions*

When analysing and evaluating the interactions in synchronous virtual environments and classrooms we are clearly tackling different problems. A model of very simple analysis is defined by Simoff (2000), who suggests examining the text of a chat session, calculating the total number of lines and locating the number of lines which expressly contain statements (*utterances*), so that the two values are placed in relationship. The formula is:

$$\frac{\text{number of lines that contain statements}}{\text{total number of lines}}$$

The higher the ratio (that is closer to value 1), the more significant the synchronous discussion should be, while a lower ratio (significantly below 1) would be indicative of a decidedly emptier “chatting”. In a second example, Simoff then suggests setting the results obtained in relation to an ulterior datum of a qualitative character, calculating in percentages, in the lines that contain statements, how many statements are effectively relevant to the subject of discussion, in comparison to significant but non-relevant statements. If the percentages of subject-related statements exceeds 50% of the total we can consider that the chat – which Simoff calls “asynchronous seminar” evidently imagining experiences firmly based in a context of piloted learning – has had a certain success and has produced appreciable results. The advantage of having the synchronous conversations at one’s disposal (almost all chat environments are textual) can even allow for a more analytical rereading of the interactions, oriented towards evaluation on an exclusively qualitative basis. This type of analysis is often aimed at verifying the participants’ attitudes to synchronous interaction with interlocutors, starting from the assumption that the synchronous experience is above all a moment of socialisation (Murphy & Collins, 1997) and that representing and projecting oneself is, in all likelihood, the most difficult obstacle to overcome in this type of environment (Giese, 1998). Murphy & Collins (1997) propose a decoding grid by means of which the principle communicative conventions adopted by the participants in the “chatting” can be identified:



- tendency to continue a sentence from one line to the next using brackets, continuation dots etc.;
- use of *emoticons* in the context of a statement;
- tendency to “flaming” (attacking other interlocutors in a dogmatic way);
- use of abbreviations for synthesising commonly used expressions);
- use of nicknames and references to people’s names;
- use of immediate communicative techniques for sharing statements or indicating a certain interest in a certain subject;
- tendency to intersperse humorous moments in the conversation;
- tendency to request explanations;
- use of frequent references to interlocutors present, as if to reinforce the sense of one’s own presence in the social context;
- tendency to assume or to confirm a certain status (for example that of the moderator of the discussion in course);
- use of techniques, expressions or punctuation marks to emphasise the statement.

Through careful analysis of the dynamics in progress in *chatting* sessions in the educational context, by means of this grid the authors themselves noted in particular the frequent recourse to the so-called “sharing of meanings”, consisting in the need to continually side with one or other interlocutor thus effectively confirming one’s own social “position”. It must be noted that analyses of this kind, and more generally any analyses of synchronous interaction, are particularly significant when the users involved have the same level of familiarity with the instrument used and are accustomed to certain features of the speed and essentiality characteristic of synchronous communication. Effectively, one of the limitations of *chatting* is the relative degree of skill in using the system that is required of those involved (all of whom need, for example, to know how to type at a certain speed), in the absence of which distinct inequalities among the interaction participants can arise, with a consequent communicative gap between novices and expert users. This latter situation occurs much more rarely and produces a minor impact on asynchronous environments. Certain more specific platforms for the management of synchronous interactions in a virtual classroom, based on tools for audio or video conferences, shared blackboards and other instruments of resource-sharing and real-time participation, instead attempt to reproduce as faithfully as possible situations and interactions similar to those that would occur in a face-to-face classroom<sup>10</sup>: in these cases the analysis of interactions and the monitoring of the process are based on traditional models (direct comparison of the interest shown by the participants, immediate feedback as regards requests for explanation, specific questions asked of individual students to check the level of attention or the acquisition of concepts and information ...), taking advantage of the precious sup-

---

<sup>10</sup> An example of a specific platform for the creation of a synchronous virtual classrooms is *Learn Line*. On the Internet, <http://www.iline.com>. Several case studies of the application of the platform in various educational contexts and of the results of the monitoring that took place are also published on the site

port offered by the fact that what happens is constantly registered and documented by the system and can be recuperated by the server or on the teacher's workstation.

### **Strong points and risk factors in the collaborative online strategies**

Any standard of analysis oriented towards decoding the interaction in progress in a virtual learning area risks being only an abstract exercise if one forgets to place the analysis in relation to the specific context in which it operates. The context is first of all represented by components of the virtual classroom, the level of homogeneity, or conversely of heterogeneity, of which could produce precise consequences in the way they interact. How much does the being in tune of those involved count? Is it always better to try to stimulate homogeneity? Or can heterogeneity prove to be a source of richness and success? Similarly, the analysis of interactions must be set in relation to the collaborative strategies operating between the components of the virtual classroom. The risk of communicative overload or, on the contrary, the risk of the dispersion or lowering of the interaction rhythm to a level beneath which the virtual community begins to perceive a sensation of inactivity, are often linked to the modes of classroom collaboration. We can thus state that in setting up a virtual classroom two complementary demands come into play: the need to recreate a perceptible and recognisable learning environment (one, as such, oriented towards stimulating a sense of homogeneity, at least of interests and intentions) and the need to tackle the variegated operational interaction modalities that are established between the different protagonists in any network of relationships.

The advantages of homogeneity between the components of a virtual classroom are evident: beyond the community of intentions and interests (that can make an online discussion, if not more profitable, at least more easily manageable), a group that collaborates online tends to be more concrete and productive if there are from the start specific similarities of profile in the elements that are taking part – similarities, for example, in the level of familiarisation with the technology used, or in the features of the respective normal work contexts. Although the problem is rarely dealt with in an explicit way, it can be observed that in many documented cases of success in online education experiences one of the prerequisites for success is precisely the relative homogeneity of the participants (Trentin, 1999). An initial axiom could be framed: to order to set up an effective virtual classroom, we need to identify one or more common traits in the components, so that dialogue and negotiation can immediately focus on the contents, without getting lost in the preliminary phases which are otherwise necessary, either to enable everyone to collaborate on the same level or to rapidly discover a meeting point of interest to all. The homogeneity of the group can thus be considered its strong point. But this same strong point can contribute to creating critical moments where the axiom has not been deliberately applied, that is in the majority of the cases or, to an even greater extent, when the possible negative implications are not considered. If it is true that some analogies of interests or of skills contribute to creating a more productive climate, this can, in fact, entail the risk that, within in a larger and more varied “de jure” group, a “de facto” subgroup can be created which, being able to operate in a homogeneous way and being motivated to do so through similarity of interests and styles, tends to exclude the rest of the community or,

in extreme cases, even to set itself up as a sort of “caste” removed from the rest of the social context. This is what happens with a certain regularity in many public discussion groups on specific themes (Calvani & Rotta, 1999, pp. 121-123). Then one must ask oneself: how should one intervene in these cases? How should one introduce new equilibrating factors when situations oriented towards a dissimilarity and disintegration emerge? In effect, the problem does not concern so much intentional groups, where one deliberately becomes a member of a project, as generally happens in online education activities aimed at adults. Forms of “stratification” are not a risk in these cases; at most there may be some incomprehension. Above all, the problem concerns the co-operative online activities (and more generally all the co-operative activities supported by the new technologies) in which non-intentional and thus more heterogeneous groups participate. It is important to identify strategies that can reduce the risk. If, for example, it is thought that the risk of stratification into castes inside the group is real, this guideline working hypothesis could be considered.

1. Make room for a preliminary phase of collaborative activities aimed at bringing all components of the group to a minimum common level of familiarisation with the technology that has been chosen for use, and identify common transversal interests.
2. Precede the real activity with a phase of reciprocal introductions and dialogue, to give a sense of community and above all so as to see whether there are elements of risk, such as components of the group who are excessively present or conversely too absent.
3. Focus on strategies of more sequential collaboration which impose a “passage from hand to hand” necessitated by the assignments, in such a way that all are called upon to make their contribution to the common construction of an object or a project.

Elements of heterogeneity, on the other hand, as well as being potential factors of instability, could also be considered bearers of richness and be seen for the positive benefits that they can produce in a virtual classroom. In general, a virtual community must have its own “sense” and identity, which is usually constructed by a careful dosing of innovations and surprises on one side, and continuity and restrictions on the other, alternating the pleasure of receiving e-mails from interlocutors with whom a certain sympathy has been established with the fulfilment of certain duties and the respect of the deadlines that define the common scenario in which one moves. From the reflections on CMC, particularly when there is reference to learning environments of a collaborative character or in which peer-to-peer relationships are established, certain elements emerge that Berge & Collins (1995) have already pointed out as focuses of primary importance for all research in this field:

- A. there are different learning styles and it is necessary to respect and value them;

- B. students tend to create their own meanings in the moment in which they are learning;
- C. the difference in the skill of understanding a concept or acquiring knowledge is due not so much to the teacher's actions or to his/her ability, as to the fact that the students feel encouraged to proceed independently (and have tools to do so at their disposal).

These considerations lead one to believe that educational success, in the online education experience, is not strictly connected to the composition of the virtual classroom, but rather to the fact that the components of the class, however heterogeneous they may be, can see and identify themselves in the learning environment and understand from these different points of view the importance of collaboration and sharing. If we accept the idea that collaboration in a virtual classroom can make learning easier for the individuals involved, then we must necessarily identify the strategies which can greatly increase the collaborative dimension. On this point Andrusyszyn (1996) places particular emphasis, suggesting that we "help learners make connections between what they are learning in class and their personal experiences and knowledge; we have to integrate in the course learning activities that will stimulate critical and reflective thought". Biolghini & Cengarle (2000, p. 11) tackle the same theme, identifying a strategy at certain points to "stimulate reflection on the new way of teaching on the part of those to whom the educational initiatives are directed". Among the things to be done: explain the proposed didactic model; point out the advantages of collaborative learning as regards individual work; promote useful attitudes to group work. We can identify and summarise various working hypotheses on how to proceed to stimulate collaborative activity in virtual classrooms. Doherty (1998) accepts, albeit critically, the idea that the student must exercise a form of self control over the learning process and thus suggests aiming above all at innovations in the design of online learning environments. These should be more oriented towards stimulating and guiding the control exercised by students over resources and over meanings, should allow access to different levels of interaction (thus guaranteeing respect for individual learning styles) and should be more attentive to concepts of usability. Murphy, Mahoney & Harvell (2000), instead, aim at the construction of the sense of the virtual community, proposing to put into effect the practice of the *learning contract*: veritable agreements concerning primarily the learning objective from the students' point of view. The authors rightly underline how in almost all cases all that is established is a sort of "contract" between the teacher and the students (for example when the teacher illustrates objectives and methodologies), while we neglect the need to draft a letter of intent which clarifies in what way the students can suggest variations in the educational course which could contribute in a significant way to the cohesion of the virtual class and to the development of a more profitable collaborative strategy. Finally Stathakos & Davie (2000) try to identify an effective strategy for encouraging collaboration aiming at the so-called *learning partnership*. The authors start from the assumption that a collaboration between a tutor/mentor and the students cannot be depicted as a peer-to-peer collaboration and thus cannot represent an ideal solution (O'Donnell & Dansereau, 1992).

On the other hand, the attempts oriented towards establishing a profitable collaboration in relatively large groups of students, if not conducted with extreme skill, could give rise to forms of unproductive antagonism or to the inevitable risk of communicative *overload*. Thus we envisage a situation in which a more specific partnership is activated, typically between two students who, as absolute peers, can reciprocally help each other to successfully achieve some of the objectives of the online course. This collaboration between two interlocutors, which the authors themselves sometimes call a “collaborative dyad”, is described as “the smallest possible social unit”. In a virtual classroom, the activation of these forms of collaboration between partners can be translated into certain added values:

- the partners contribute to a greater extent to creating a collegiate climate in the learning environment and to the creation of a community capable of constructing knowledge;
- the presence of peer partners creates the premises for a more motivating climate in the classroom;
- the partnership contributes to solving many of the socio-emotional problems which sometimes characterise an online learning environment, and helps combat the sense of stress and of frustration characteristic of many experiences;
- two partners who collaborate, in short, obtain immediate advantages as regards various cognitive demands, for example being able to divide the assignment of reading and synthesising a document and contemporarily comparing the syntheses produced;
- experiments on the *learning partnership* are being carried out in particular in the Canadian environment, where the theories of *peer tutoring* have been elaborated and are constantly applied.

An ulterior problem is represented by the sustainability of online collaborative activities: do online interaction and collaborative techniques increase “productivity”? Do they improve the quality of the process? Or are the energies expended in excess of the results reached? As we have already seen, Elliott Masie frequently touches on the theme of the sustainability of online learning activities, stressing the fact that we tend to be excessive, demanding too much productivity of students who are usually working adults with little time at their disposal. The problem of the sustainability of an online course must actually be set within a much larger context: sometimes we speak of *flexible learning* emphasising above all that it is the design of the virtual learning environment that influences the effective sustainability of the course on the part of the students (Bates, 1996; Freeman, 1997). Some crucial factors which can contribute to making an online education experience more or less sustainable can be singled out:

- the number of components who collaborate in view of a common end; and

- the possibility on the part of the tutors or moderators to manage the group in an optimal way;
- the roles assumed by the protagonists, whether these are effective or specifically assigned;
- the general characteristics of the virtual community and the modalities used in online work.

The idea that relatively compact groups of students are more productive than larger groups, and thus guarantee a greater sustainability for the experience, has been brought up many times. Andrusyszyn (1996) suggests various strategies for organising effective and productive activity groups, without however defining orders of magnitude in abstract terms: according to the Canadian academic it can be thought that a relatively small group, from 3 to 5 components, can work in an efficient way above all when it is intended to promote peer tutoring among the participants. As we have seen earlier, there are those who propose the activation of collaborative “couples”.

Andrusyszyn, nevertheless highlights how even more numerous groups, from 12 to 20 persons, are interesting when what counts is stimulating knowledge sharing (in this case a higher number implies the possibility of making greater use of the range of expertise present in the individuals) and the construction of a social learning context. It is, moreover, very likely that in courses oriented towards the production of fairly ambitious projects, a larger group can facilitate a more equal and sustainable distribution of the workload. Palloff and Pratt (1999) return to this subject, highlighting the difference between synchronous learning environments, where they suggest always starting with small groups of 5-10 persons at most, and asynchronous environments, where instead, even in a context oriented towards a certain economy of scale, one can work with larger groups. According to Palloff and Pratt it is not so much the dimension of the group that introduces the risk of communicative overload, as the way in which the tutor organises the activity, bearing in mind the composition and the attitude of the components of the virtual classroom.

The other two critical factors identified are closely connected to each other. For example, various typologies of networking can be established between the components of a virtual classroom, which inevitably influence the manageability of the process and group productivity in general (Turoff, 1995; Ravitz, 1999).

On the basis of the networking characteristics, the process will result more sustainable by intervening on the dimensions of the work groups, and on the role, or rather the “weight” of the moderator, the tutor and other co-ordinating figures (Palloff & Pratt, 1999).

We can thus try to summarise in tabular form the relations between the type of relationship, the size of the online group and the role of co-ordinating or moderating figure:

TYPE OF RELATIONSHIP NETWORK	SIZE OF DESIRABLE AND/OR SUSTAINABLE WORK GROUPS	CHARACTERISTIC ACTION OF THE TUTOR, MODERATOR OR CO-ORDINATING FIGURE
<i>Personal</i> : a relationship network between members of the same social category (Ravitz, 1995)	Medium	Moderation
<i>Topical</i> : the set of communicative and co-operative dynamics taking place among all those who are interested in a specific subject (Turoff, 1995)	Medium	Moderation and animation
<i>Peer</i> : the interactions taking place among groups on the same level relating to the solution of common problems (Salmon, 1998)	Small	Support
<i>Synthesis</i> : the interactions taking place among collaborative groups working under the guidance of a trainer or a teacher (Salmon, 1998)	Medium/small	Facilitation or <i>coaching</i>
<i>Clearinghouse</i> : the dynamics oriented towards the managing of large quantities of information and of knowledge management	Large	Co-ordination and organisation
<i>Brokering</i> : the interaction taking place among those working online submitting specific problems to experts who react <i>on demand</i> (Tidwell, 1999)	Medium/large	Mediation and dialogue

Furthermore the attitudes of the students themselves, which can be quite variegated, must be considered. Effectively, beyond the social and cultural homogeneity or heterogeneity of the components of the virtual classroom, it has been correctly underlined (Trentin, 1999, pp. 200-203) how in online activities the individual participants tend to develop a variegated range of “virtual personalities”; these include the *lurker*, who observes what the others are doing but does not participate because of laziness or bad faith; the *ever-present*, who continually tries to affirm his/her own existence; the *know-it-all*, who believes that he can express opinions on any subject; the *prussian*, who only moves on the basis of precise orders; the *transgressor*, who tends to deliberately not respect the rules, and finally the *worrier*, who continually reveals his/her sense of inadequacy. These are types of conduct which are difficult to manage. We have to prevent people persisting in their initial attitudes, and intervention has to be made to gradually modify the situation. This is one of the duties of the tutor or group co-ordinator, who Paulsen (1995) suggests should aim at creativity, adopting for example inside the course itself different “formats” of online interaction, in a flexible and open way. The productivity of a collaborative online group is thus linked in part to the sustainability of the process, but also plays on an ulterior and complex intertwining of factors: the ability to enhance existing skills and increase motivation and the ability to establish at the same time a climate of profitable relationship, of enthusiasm and of realism. High involvement learning methodologies are held to be

particularly profitable, and are summarised in the expression *Engaged Learning* with which various authors, especially Kearsley and Schneiderman (1999), indicate a situation in which at least three characterising elements are found:

- presence of a collaborative context and activation of collaborative dynamics among the participants in the experience (*relate*);
- activities oriented towards the development of projects (project-based learning) and to the solution of concrete problems (*create*);
- focus on authenticity, that is to say results which are reusable or have a practical application, the latter element according to the authors can play a fundamental role in the motivation of the learning group and consequently of its productivity (*donate*).

### **Criteria for making interaction and collaboration in a virtual classroom more efficient**

The analysis of the quantity and quality of the interactions possible in the synchronous and asynchronous environments can help us to identify which are the knots to be unravelled, and more generally to understand whether a significant collaborative construction of knowledge is effectively taking place inside the social space in which the components of a virtual classroom are moving. There remains the problem of how to intervene to modify situations in which problems and difficulties are found, or how to manage a process in which so many variables come into play. Many recommendations on designing virtual learning environments are in reality suggestions on how to manage the interaction inside the group which works online and on how to foster the growth of a positive climate. Even Harasim (1994) moves in this direction, identifying various attitudes/actions that those in charge of planning, and especially of managing, the online education experience should develop and maintain to make collaborative learning easier and to guarantee the success of the interactions. These “golden rules” are often elaborated thinking either of online interaction dynamics in general and in spontaneous situations (for example the mailing-list) or, on the contrary, in well-defined and circumscribed experiences (for example the activation of a students’ forum on a campus). Effectively, to be able to define criteria useful for clarifying the dynamics that are established in a virtual classroom there are at least three elements to be considered: the concept of *Virtual Classroom* itself, the roles of those acting within that particular context, and the dynamics of interaction. In relation to this, we would like to attempt to draw up a more articulated diagram of the action and behaviour that reflects positively on the progress of an asynchronous discussion or, more generally, on the collaborative interaction within a virtual classroom, taking cues from Berge & Collins (1995), Andrusyszyn (1996), Kubala (1998), Palloff & Pratt (1999), Draves (2000) and Shepherd (2000b; 2000c). For this diagram to be useful, several assumptions must be accepted, in particular the establishment of a minimum configuration of potential actors operating within this context, naturally aiming at the principal “protagonists”: the students, the tutor or teacher, the hypothetical “area experts”, and a “monitor” - that is a person who analyses and evaluates the experience. The table illus-



trates the idea (Pause, in Berge & Collins, 1995) that the actions of each individual produce effects on at least three distinct levels:

- social;
- intellectual;
- organisational/managerial.

Then for each of the three levels, the positive and effective actions that each individual can, or rather should, perform to create a profitable collaborative climate and to make the virtual learning environment productive and sustainable are indicated. It is clear that this breakdown is indicative and does not presume to be a “recipe” for success, particularly in view of the fact that the various actions indicated here should be submitted to careful decoding and analysed in detail.

Regarding interaction in the synchronous environment it must be said that many of the recommendations in the above table could be proposed. In reality, the “background noise” that characterises almost all *chatting* sessions sometimes makes it almost impossible “to meditate” interaction, and consequently to pilot the progress of a discussion or simply to keep a minimum of *netiquette*. Trentin (1998) declares that “too much synchronisation can produce an overlapping of information, with a consequent reduction of the efficiency of the group work”. Others, analysing the synchronous communication environment in depth, have pointed out how the management of a chatting area is complex because of factors linked to the lack of a reference code in conversation: “the lack of actual physical presence, indeed the often great physical distances between individual par-

INDIVIDUAL	POSITIVE OR EFFECTIVE ACTIONS ON THE SOCIAL LEVEL	POSITIVE OR EFFECTIVE ACTIONS ON THE INTELLECTUAL LEVEL	POSITIVE OR EFFECTIVE ACTIONS ON THE ORGANISATIONAL AND MANAGERIAL LEVEL
<b>Everybody</b>	<ul style="list-style-type: none"> <li>• Respect <i>netiquette</i></li> <li>• Avoid using instruments at disposal inappropriately</li> </ul>	<ul style="list-style-type: none"> <li>• Use a simple and clear language as much as possible</li> <li>• Try to always concentrate upon the problem being dealt with and keep as closely as possible to the subject under discussion</li> </ul>	<ul style="list-style-type: none"> <li>• Respect the deadlines</li> <li>• Define the subject of messages or titles of documents so as to make the contents as clear as possible</li> </ul>
<b>Tutor, moderator or teacher</b>	<ul style="list-style-type: none"> <li>• Define clearly and as binding the rules of <i>netiquette</i></li> <li>• Follow and constantly moderate the discussions in progress</li> <li>• Maintain a constant attitude of neutrality</li> <li>• Help in particular those who appear to be in greater</li> </ul>	<ul style="list-style-type: none"> <li>• Bring the environment constantly up-to-date, proposing subjects for discussion, resources, activities</li> <li>• Inform in time on eventual updates</li> <li>• Respond rapidly to every request for help</li> </ul>	<ul style="list-style-type: none"> <li>• Control the mail at least twice a day</li> <li>• Access forums every day</li> <li>• Clarify the specific use that will be made of various technological tools</li> <li>• Eliminate double messages from the forum, remove or file material pertinent</li> </ul>

	difficulty	<ul style="list-style-type: none"> <li>• Constantly encourage the active participation of students</li> </ul>	<ul style="list-style-type: none"> <li>to closed discussions</li> <li>• Locate co-ordinating figures in workgroups</li> </ul>
<b>Area expert</b>	<ul style="list-style-type: none"> <li>• Elaborate materials considering the specific characteristics of the recipients, avoiding use of a language unsuitable for the audience</li> <li>• Avoid assuming a role of protagonist in the discussions</li> </ul>	<ul style="list-style-type: none"> <li>• Constantly verify the pertinence between didactic objectives and contents</li> <li>• Enrich participation with references to other resources as much as possible</li> <li>• Take care above all to suggest resources available online or easily found</li> </ul>	<ul style="list-style-type: none"> <li>• Guarantee active participation at events, seminars or discussions that require the presence of an expert</li> </ul>
<b>Monitor</b>	<ul style="list-style-type: none"> <li>• Avoid entering into discussions in progress</li> <li>• Avoid letting this role be perceived as a form of control on the classroom</li> </ul>	<ul style="list-style-type: none"> <li>• Indicate eventual critical situations observed in the open virtual classroom to the tutor or the other figures involved in time</li> </ul>	<ul style="list-style-type: none"> <li>• Control the mail regularly</li> <li>• File all messages and material</li> <li>• Keep an up-to-date outline of the progress of the discussion under way</li> </ul>
<b>Student</b>	<ul style="list-style-type: none"> <li>• Use a clear and impersonal language as much as possible, in line with the characteristics of the instrument used</li> <li>• Clarify eventual difficulties or doubts trying to overcome fears and shyness</li> </ul>	<ul style="list-style-type: none"> <li>• Keep an open attitude to exploration</li> <li>• Constantly share with the others one's own experience and one's own opinions on the subjects dealt with</li> </ul>	<ul style="list-style-type: none"> <li>• Control the mail at least once a day</li> <li>• Access the forum at least 3 times a week</li> <li>• Acquire as soon as possible the technical skills necessary to use the instruments proposed by the organisers</li> </ul>

participants, demands that a new set of behaviour codes be invented if the participants are to make sense of and understand each other” (Murphy & Collins, 1997). Moreover, unlike what happens when participating in an asynchronous discussion, in a distance synchronous confrontation it is more difficult for those directly involved to remain detached: their attention is continually absorbed by a rapid succession of e-mails and by the need to choose the right moment to intervene, since it is not possible to understand whether or not the interlocutors are paying attention to our desire to participate (Giese, 1998). This leads one to believe that in a synchronous interaction the threshold of the participants’ attention is constantly very high, higher than it is in asynchronous interaction (Mameli, 1997). The management of the interaction moment itself is the subject of specific studies (Murphy & Collins, 1997; Giese, 1999), which focus on analysing the way in which the actors interpret their roles on the synchronous scene, above all from the psychological point of view. The attitudes which emerge do not differ greatly, in certain respects, from those found in the asynchronous environments.

## BIBLIOGRAPHY

- Allen R.J. (2000), *Step Right Up! Real Results for Real People! Computer-based Multimedia Training can make a Big Difference, if it is done right*. Allen Communication White Paper. On the Internet, <http://www.allencomm.com/software/quest/whtpgs/>
- Althaus S.L. (1997), *Computer-mediated communication in the university classroom: An Experiment with On-line Discussions*. "Communication Education", 46(3): 158-174.
- Anderson T. (1997), *Integrating lectures and electronic course materials*, Innovations in Education and Training International, 34(1): 24-31.
- Andres Y., Clauset T., Jacks M. & Rogers A. (1990), *Telecommunications in the Classroom: Keys to Successful Telecomputing* The Computing Teacher, 17(8): 25-28. On the Internet, <http://www.gsn.org/teach/articles/>
- Andrusyszyn M.A. (1996), *Instructor's Guide to Computer Conferencing* On the Internet, <http://publish.uwo.ca/~maandrus/Table.htm>
- Baer W.S. (1999), *E-Learning a Catalyst for Competition in Higher Education*, IMP. Information Impacts Magazine, giugno 1999. On the Internet, [http://www.cisp.org/imp/june\\_99/](http://www.cisp.org/imp/june_99/)
- Berge Z. (1995), *The Role of the Online Instructor/Facilitator*, in Berge Z., *Facilitating Computer Conferencing Recommendations from the Field*. Educational Technology, 35(1):22-30. On the Internet, [http://jan.ucc.nau.edu/~mpc3/moderate/teach\\_online.html](http://jan.ucc.nau.edu/~mpc3/moderate/teach_online.html)
- Berge Z. & Collins M. (1995), *Computer-mediated Communication and the Online Classroom: Overview and Perspectives*. 3 vol., Cresskill, NJ, Hampton Press.
- Berge Z. & Collins M. (1996), *Wired Together: The On-line Classroom in K-12*, 4 Vol. Cresskill, NJ, Hampton Press.
- Bilotta E., Fiorito M., Iovane D. & Pantano P. (1995), *An Educational Environment Using WWW*, Third International World Wide Web Conference, Darmstad, 1995. On the Internet, <http://www.igd.fhg.de/www/www95/proceedings/papers/author.html>
- Bilotta E., Calabrò G., Langella F. & Pantano P. (1998), *A Virtual Classroom Model Based on Teaching/Learning Activities*. On the Internet, <http://uni.abramo.it>
- Biolghini D. & Cengarle M. (2000), *Net Learning Imparare insieme attraverso la rete* Milano, Etas.
- Blight D., Davis D. & Olsen A., *Internalisation of higher education*, in Harry K., *Higher Education Through Open and Distance Learning* World review distance education and open learning series. Vol. 1 London and New York, The Commonwealth of Learning, Routledge, 15-31.
- Bracewell R., Benoit J., Abdous M. & Laferrière T. (1998), *The Emerging Contribution of Online Resources and Tools to Classroom Learning and Teaching* Report per SchoolNet Rescol / TeleLearning Network. On the Internet, <http://www.tact.fse.ulaval.ca/ang/html/>
- Britain S. & Liber O. (eds.), *A Framework for Pedagogical Evaluation of Virtual Learning Environments*. On the Internet, <http://www.jtap.ac.uk/reports/htm/jtap-041.html>
- Brown A.L. & Campione J.C. (1990), *Communities of Learning and Thinking, or a Context by any other Name*, Contributions to Human Development, 21: 108-126.
- Brown A.L. & Campione J.C. (1994), *Guided Discovery in a Community of Learners*, in K. Mc Gilly (a cura), *Classroom Lesson: Integrating Cognitive Theory and Classroom Practice*, MIT Press, Bradford Book, Cambridge, MA, pp. 229-270.

- Burge E. & Roberts J.M. (1993), *Classrooms with a Difference: A Practical Guide to the Use of Conferencing Technologies*, Distance Learning Office Field Services and Research, The Ontario Institute for Studies in Education.
- Calvani A. & Rotta M. (1999), *Comunicazione ed apprendimento in Internet. Didattica costruttivista in rete*, Trento, Erickson.
- Calvani A. & Rotta M. (2000), *Fare formazione in Internet*, Trento, Erickson.
- Collins A. (1996), *Design Issues for Learning Environments*, in S. Vosniadou, E. De Corte, R. Glaser & Mandl H. (eds.), *International Perspectives on the Design of Technology-Supported Learning Environments*, Lea, NJ, 1996, pp. 347-361.
- Collis B. & Knezek, (eds.) (1997), *Teaching and Learning in the Digital Age: Research into Practice with Telecommunications in Educational Settings*. Selected Papers of the Tel\*Ed '97 Conference, Austin, TX and Mexico City, Mexico, November.
- Cotton, E.G. (1998), *The On-line Classroom: Teaching with the Internet*. Bloomington, IN, EDINFO Press.
- Davie L.E. & Wells R. (1991), *Empowering the Learner through Computer-mediated Communication*, The American Journal of Distance Education, 5(1): 15-23.
- Davies J.E. (1997), *Learn by Wire: Managing Networks Access to Learning Materials*, The Electronic Library, 15(3): 205-214.
- Davis B. (1994), *Teacher of the future*, 2<sup>nd</sup> Conference on Educational Computing, Educational Computing Multi-Environments, University of Athens. On the Internet, <http://www.mit.edu/people/davis/>
- DeKerckhove D. (1993), *Brainframes. Mente, tecnologia e mercato*, Bologna, Baskerville.
- Dede C. (1994), *The transformation of Distance Learning to Distributed Learning* Instructional Technology Research Online, George Mason University. On the Internet, <http://www.gsu.edu/~wwwitr/docs/distlearn/index.html>
- Deden A. (1998) *Computers and Systemic Change in Higher Education*, Communications of the ACM, 41(1): 58-63.
- Doherty P.B. (1998), *Learner Control in Asynchronous Learning Environments*. ALN Magazine, 2(2), ottobre 1998. On the Internet, [http://www.aln.org/alnweb/magazine/vol2\\_issue2](http://www.aln.org/alnweb/magazine/vol2_issue2)
- Downes S. (1998), *The Future of Online Learning* On the Internet, <http://www.atl.ualberta.ca/downes/future/welcome.htm>
- Draves W. (2000), *Teaching online*, River Falls, Wisconsin, LERN Books.
- Driscoll M.M. & Alexander L. (1998), *Web-based Training Using Technology to Design Adult Learning Experiences*, San Francisco, CA, Jossey-Bass.
- Dwyer D., Barbieri K. & Doerr H.M. (1995), *Creating a Virtual Classroom for Interactive Education on the Web*, Third International World Wide Web Conference, Darmstad. On the Internet, <http://www.igd.fhg.de/www/www95/proceedings/papers/ctc.virtual.class.html>
- Freeman M. (1997), *Flexibility in Access, Interaction and Assessment: the Case for Web-based Conferencing and Teaching Programs*, Australian Journal of Educational Technology, 13(1): 23-39. On the Internet, <http://cleo.murdoch.edu.au/gen/aset/ajet/ajet13/wi97p23.html>
- Galimberti C. & Riva G. (eds.) (1997), *La comunicazione virtuale, dal computer alle reti telematiche: nuove forme di interazione sociale*, Guerini e Associati, Milano.

- Garito M.A. (1996), *La multimedialità nell'insegnamento a distanza*, Roma Garamond.
- Garton L., Haythornwhite C. & Wellman B. (1999), *Studying On-line Social Networks*, in Jones S. (ed.) *Doing Internet Research, Critical and Methods for Examining the Net*, Thousand Oaks, CA, London, New Delhi, Sage Publications, pp. 75-100.
- George P.G. (1994), *The Effectiveness of Cooperative Learning Strategies in Multicultural University Classrooms*, *Journal on Excellence in College Teaching*, 5(1): 21-29.
- Giese M. (1998), *Self Without Body: Textual Self-Representation in an Electronic Community*, "First Monday", Peer Reviewed Journal on the Internet, 3, 4. On the Internet, [http://www.firstmonday.dk/issues/issue3\\_4/giese/index.html](http://www.firstmonday.dk/issues/issue3_4/giese/index.html)
- Gilbert K.R. (1997), *Teaching on the Internet: the World Wide Web as a Course Delivery System*. Indiana University. On the Internet, [http://www.ind.net/distance\\_ed/fdpapers/1997/gilbert.html](http://www.ind.net/distance_ed/fdpapers/1997/gilbert.html)
- Gladieux L.E. & Swail W.S. (1999), *The Virtual University & Issues of Equity and Access for the Next Generation Educational Opportunity*. Washington DC, The College Board.
- Grégoire R. & Laferrière T. (1998), *Collaborative Project-based Learning A Guide for Teachers*. Industry Canada SchoolNet.
- Gunawardena C.H. & Zittle, R.H., *Faculty Development Programmes in Distance Education in American Higher Education*, in Latchem C. & Lockwood F., *Staff Development in Open and Flexible Learning* Routledge, London, 1998, pp. 105-114
- Hall B. & Driscoll M. (2000), *Live E-Learning: How to Choose a System for Your Organization*. Brandon Hall Consulting. On the Internet, <http://www.internetconnect.net/~bhall/lel/lel.html>
- Hara N. & Kling R. (1999), *Student's Frustration with a Web-based Distance Education Course*, First Monday, 4,12. On the Internet, [http://www.firstmonday.dk/issues/issue4\\_12/hara/index.html](http://www.firstmonday.dk/issues/issue4_12/hara/index.html)
- Harasim L. (1990), *Online Education: Perspectives on a New Environment*, New York, Praeger.
- Harasim L. (1995), *Learning Networks: a Field Guide to Teaching on Learning Online*, Cambridge, MA, MIT Press.
- Harasim L.M. (1997), *Interacting in Hyperspace: Developing Collaborative Learning Environments on the WWW*. On the Internet, <http://www.umuc.edu/iuc/workshop97/harasim.html>
- Harasim L., Hiltz S.R., Teles L. & Turoff M. (1995), *Learning Networks: A Field Guide to Teaching and Learning Online*. Cambridge, MA, MIT Press.
- Harrison N. (1996), *Practical Instructional Design for Open Learning Materials: a Modular Course Covering Open Learning, Computer-based Training, Multimedia*. New York, McGraw-Hill.
- Harry K. (1999), *Higher Education through Open and Distance Learning*, "World review of distance education and open learning series", vol. 1, London and New York, The Commonwealth of Learning, Routledge.
- Hegarty M., Phelan A. & Kilbride L. (eds.) (1998), *Classrooms for Distance Teaching and Learning A Blueprint*. Leuven, Belgium, Leuven University Press.
- Herz J.C. (1995), *Surfing on the Internet*, 1995. Trad. it. *I surfisti di Internet*, Milano, Feltrinelli.
- Hewitt J., Scardamalia M. & Webb J. (1997), *Situative Design Issues for Interactive Learning Environments: The Problem of Group Coherence*. CSILE. On the Internet, URL:[http://csile.oise.utoronto.ca/abstracts/situ\\_design/](http://csile.oise.utoronto.ca/abstracts/situ_design/)
- Hiltz S.R. (1994), *The Virtual Classroom. Learning Without Limits Via Computer Networks*, Norwood, Ablex Publishing.

- Hiltz, S.R. & Wellman, B. (1997), *Asynchronous Learning Networks as a Virtual Classroom*, Communications of the ACM, 40(9): 44-49.
- Jacobson M.J & Levin J.A. (1993), *Network Learning Environments and Hypertext: Frameworks for Constructing Personal and Shared Knowledge Spaces*, "Proceedings of Tel-Ed 93", a cura di D.Foster e D.V.Jolly, Dallas TX, International Society for Technology in Education.
- Jaffee D. (1997), *Asynchronous Learning: Technology and Pedagogical Strategy in a Computer-mediated Distance Learning Course* Teaching Sociology, 25(4): 262-277. On the Internet, <http://www.newpaltz.edu/~jaffeed/esstxx.htm>
- Jonassen D.H., Davidson M., Collins M, Campbell J. & Haag B.B. (1995), *Constructivism and Computer-mediated Communication in Distance Education*, The American Journal of Distance Education, 9(2): 7-26.33
- Jones S. (ed.) (1999), *Doing Internet Research, Critical Issues and Methods for Examining the Net*, Thousand Oaks (Ca), London, New Delhi, Sage Publications.
- Jorn L.A., Duin A.H., & Wahlston B.J. (1996). *Designing and Managing Virtual Learning Communities*. IEEE Transactions on Professional Communication, 39(4): 183-191.
- Kanuka H. & Kreber C. (1999), *Knowledge Construction in the Virtual Classroom*. ACEEA/CASAE Internet Working Group. University of Alberta. On the Internet, <http://www.oise.utoronto.ca/CASAE/cnf99/>
- Kearlsey G. (1998), *A Guide to Online Education*. On the Internet, <http://www.fcae.nova.edu/~kearlsey/online.html>
- Kearsley G. (2000), *Online Education: Learning and Teaching in Cyberspace* Belmont, CA, Wadsworth.
- Kearsley, G. & Shneidermann B. (1999), *Engagement Theory: a Framework for Technology-based Teaching and Learning* On the Internet, <http://home.sprynet.com/~gkearsley/>
- Keegan D. (1994), *Principi di istruzione a distanza*, La Nuova Italia, Firenze.
- Keegan D. (1998), *L'individualizzazione dell'apprendimento: una carta vincente dei sistemi di istruzione a distanza* in IAD, X, 10/11, ag., pp.35-42
- Koschmann T.D. (1993-94), *Toward a Theory of Computer Support for Collaborative learning* The Journal of the Learning Sciences, 3(3): 219-225.
- Kubala T. (1998), *Teaching on the Internet*, T.H.E. Journal, March. On the Internet, <http://www.thejournal.com/magazine/98/mar/>
- Kumar M. & Schoonover G. (1996), *Classroom Re-engineering A Paper Discussing the Application of Existing and Emerging Technology to Realize the Concept of a Distributed Classroom Environment*. On the Internet, <http://www.sneaker.org/Papers/ClassroomReengineering.html>
- Latchem C. & Lockwood F. (1998), *Staff Development in Open and Flexible Learning*, Routledge, London.
- Lévy P. (1997), *Il Virtuale*, Raffaello Cortina Editore, Milano.
- Light P., Colbourn C. & Light V. (1997), *Computer-mediated Tutorial Support for Conventional University Course* Journal of Computer Assisted Learning, 13(4): 228-235.
- Lindner R. (2000), *Design of Electronic Learning Environments*. Darmstadt University of Technology. On the Internet, <http://www.igd.fhg.de/~lindner/>
- Maldonado T. (1992), *Reale e virtuale*, Milano, Feltrinelli.

- Margiotta U. (1997), *Pensare in rete*, Bologna, CLUEB.
- Martens R.L., Valcke M.A. & Portier S.J. (1997), *Interactive Learning Environments to Support Independent Learning: The Impact of Discernability of Embedded Support Devices*, *Computers Education*, 28(3): 185-197.
- Martin R. R. (1997), *Key Issues in Transitioning from Distance Education to Distributed Learning On the Internet*, <http://www.fcae.nova.edu/disted/spring98/martin.html>
- Masie E. (1997), *Confessions of an Online Learner*, the Masie Center. On the Internet, <http://www.masie.com/articles/>
- Masie E. (2000), *The "E" in E-learning Stands for "E"xperience*. On the Internet, <http://www.smartforce.com/corp/marketing/articles/emasie.htm>
- Mason R. (1998), *Models of Online Courses*. Proceedings of conference "Networked Lifelong Learning: Innovative Approaches to Education and Training Through the Internet", University of Sheffield. Anche in *ALN Magazine*, 2(2), ottobre 1998. On the Internet, [http://www.aln.org/alnweb/magazine/vol2\\_issue2/](http://www.aln.org/alnweb/magazine/vol2_issue2/)
- Mason R.D. & Kaye A.R. (eds.) (1989), *Mindweave: Communication, Computers and Distance Education*, Pergamon Press Oxford, UK. On the Internet, <http://wwwicdl.open.ac.uk/mindweave/mindweave.html>
- Mason R.D. & Kaye A.R. (1992), *Collaborative Learning through Computer Conferencing* Spingler Verlag, Berlin.
- McCarthy L. & Stiles R. (1998), *Enabling Team Training in Virtual Environments*, in "Collaborative Virtual Environments 98", Manchester, pp. 113-121.
- McGee P. & Boyd V. (1995), *Computer-mediated Communication: Facilitating Dialogues*. On the Internet, [http://www.coe.uh.edu/insite/elec\\_pub/html1995/](http://www.coe.uh.edu/insite/elec_pub/html1995/)
- McLean R. (1999), *Meta-Communication Widgets for Knowledge Building in Distance Education*. Ontario Institute for Studies in Education. On the Internet, <http://kn.cilt.org/csc199/A48/A48.htm>
- Meighan R. (2000), *Some Principles of Educational Reconstruction*. The 21<sup>st</sup> Century Learning Initiative. On the Internet, <http://www.21learn.org>
- Metitieri F. & Manera G. (1997), *Incontri virtuali. La comunicazione interattiva On the Internet*, Apogeo, Milano.
- Moore G.M. (1999), *Institutional Restructuring is distance Education Like Retailing?*, *AJDE*, 13(1). On the Internet, <http://www.ed.psu.edu/acsde/ajde/ed131.asp>
- Moore G.M. (1998), *Quality in Distance Education: four cases*, *AJDE*, 11(3). On the Internet, <http://www.ed.psu.edu/acsde/ajde/ed113.asp>
- Moore G.M. (1995), *The Death of Distance*, *AJDE*, 9(3). On the Internet, <http://www.ed.psu.edu/acsde/ajde/ed93.asp>
- Moore G.M. (1998), *The Global Distance Education Network*, *AJDE*, 12(2). On the Internet, <http://www.ed.psu.edu/acsde/ajde/ed123.asp>
- Moore M.G. & Kearsley G. (1996), *Distance Education: A Systems View*, New York, Wadsworth.
- Moran L. & Myringer B. (1999), *Flexible Learning and University Change*, in Harry K., *Higher Education Through Open and Distance Learning*, London and New York, The Commonwealth of Learning, Routledge, vol. 1, pp. 57-71.

- Murphy K.L. & Collins M.P. (1997), *Communication Conventions in Instructional Electronic Chats*, "First Monday" Peer Reviewed Journal on the Internet, 2, 11. On the Internet, [http://www.firstmonday.dk/issues/issue2\\_11/murphy/index.html](http://www.firstmonday.dk/issues/issue2_11/murphy/index.html)
- Murphy K.L., Mahoney S.E. & Harvell T.J. (2000), *Role of Contracts in Enhancing Community Building in Web Courses*. Educational Technology & Society, 3(3). On the Internet, [http://ifets.ieee.org/periodical/vol\\_3\\_2000/](http://ifets.ieee.org/periodical/vol_3_2000/)
- Negroponete N. (1995), *Essere digitali*, Sperling & Kupfer Editori, Milano.
- Nickerson S. (1988), *Technology in Education in 2020: Thinking About the Not-Distant Future*, in Nickerson S. & Zodhiates P. P. (eds.), *Technology in Education: Looking Toward 2020*, L.E.A., pp.1-9.
- Nipper S. (1989) *Third Generation Distance Learning and Computer Conferencing* in Mason R.D & Kaye A.R. (eds), *Mindweave: Communication, Computers and Distance Education*, chap. 5, pp 63-73, Pergamon Press Oxford, UK, taken from ICDL, British Open University database.
- O'Donnell A.M. & Dansereau D.F. (1992), *Scripted Cooperation in Student Dyads: A Method for Analyzing and Enhancing Academic Learning and Performance*, in Hertz-Lazarowitz R. & Miller N. (eds.), *Interaction in Cooperative Groups*, pp. 120-141, New York, NY, Cambridge University Press.
- Oliver R., Omari A. & Herrington, J. (1998), *Exploring Student Interactions in Collaborative World Wide Computer-based Learning Environments*. Journal of Educational Multimedia and Hypermedia, 7(2/3): 263-287.
- O'Shea T. & Scanlon E. (1997), *Virtual Learning Environments and the Role of the Teacher*. Unesco/Open University International Colloquium. Milton Keynes, August 1997. Report.
- Paccagnella L. (2000), *La comunicazione al computer*, Bologna, il Mulino.
- Palloff R.M. & Pratt K. (1999), *Building Learning Communities in Cyberspace: Effective Strategies for the Online Classroom*. San Francisco, CA, Jossey-Bass.
- Papa F. (1998), *Chi studia nell'aula virtuale vede, apprende e si confronta*, in "Telèma", 12.
- Paquette G. (1995), *Modeling the Virtual Campus*, in Collis B. & Davies G., (eds.), *Innovating Adult Learning with Innovative Technologies*, Amsterdam, Elsevier Science.
- Paulsen M.F. (1993), *The Hexagon of Cooperative Freedom: a Distance Education Theory Attuned to Computer Conferencing* DEOSNEWS, 3, 2. On the Internet, <http://www.nettskolen.com/alle/forskning/21/hexagon.html>
- Paulsen M.F. (1995), *The Online Report on Pedagogical Techniques for Computer-mediated Communication*. Electronic Report. On the Internet, <http://www.nki.no/~morten/>
- Pohjonen J. (1996), *Open University and New Learning Environments*, Lifelong Learning for the Information Society Conference, Genova. On the Internet, <http://oyt.oulu.fi/~pohjonen/lilis.htm>.
- Polyson S. & Saltzberg S. (1996), *Distributed Learning on the World Wide Web*. On the Internet, <http://www.umuc.edu/iuc/cmc96/papers/poly-p.html>.
- Polyson S., Saltzberg S. & Godwin-Jones R. (1996), *A Practical Guide to Teaching with the World Wide Web*. "Syllabus Magazine", September 1996. On the Internet, <http://www.umuc.edu/iuc/cmc96/papers/>



- Pontecorvo C., Aiello A. M. & Zucchermaglio C. (eds.) (1995), *I contesti sociali dell'apprendimento, Acquisire conoscenze a scuola, nel lavoro, nella vita quotidiana*, Ambrosiana, Milano.
- Porter L.R. (1997), *Creating the Virtual Classroom: Distance Learning with the Internet*. New York, John Wiley & Sons.
- Queau P. (1995), *Come statue di sale*, "Virtual", 3, 20.
- Rada, R. (1998), *Efficiency and Effectiveness in Computer-supported Peer-to-peer Learning* Computers & Education, 30(3-4): 137-146.
- Ravitz J. (1995), *Building Online Communities, an ID Model*. On the Internet, [http://copernicus.bbn.com/Ravitz/IDE\\_Model\\_Present.html](http://copernicus.bbn.com/Ravitz/IDE_Model_Present.html)
- Resnick D. (2000), *The Virtual University and College Life: Some Unintended Consequences for Democratic Citizenship*, "First Monday", 5, 8. On the Internet, [http://www.firstmonday.dk/issues/issue5\\_8/resnick/index.html](http://www.firstmonday.dk/issues/issue5_8/resnick/index.html)
- Resnick M. (1996), *Distributed Constructionism*, in Proceeding of the International Conference on the Learning Science, Association for the Advancement of Computing in Education, Northwestern University, July 1996. On the Internet, <http://lcs.www.media.mit.edu/groups/el/Papers/mres/Distrib-Construc/Distrib-Construc.html>
- Rheingold H. (1993), *La Realtà Virtuale*, Bologna, Baskerville.
- Rheingold H. (1994), *The Virtual Community*, Addison-Wesley, Reading (Mass), 1993. Ed. it. *Comunità virtuali. Parlare, incontrarsi, vivere nel ciberspazio*, Milano, Sperling & Kupfer Editori.
- Riel M. (1993), *I circoli di apprendimento*, TD. Tecnologie Didattiche, 2: 18-30.
- Rivoltella P.C. (ed.) (1999), *La scuola nella rete. Problemi ed esperienze di cooperazione online*, Santhià, GSE.
- Rossmann P. (1992), *The Emerging Worldwide Electronic University*, Information Age Global Higher Education, Greenwood Press, Westport, Connecticut.
- Rotta M. (1997), *Interazioni telematiche con i tutors. Prima relazione sull'esperienza Multilab, in monitoraggio multilab. la formazione dei tutor*; report 1, edited by Raimondo Bolletta, Ministero della Pubblica Istruzione, CEDE.
- Rowntree D. (1995), *The Tutor's Role in Teaching Via Computer Conferencing* Updated version for the Internet of an article published in the British Journal of Educational Technology, 26, 3, September 1995. On the Internet, <http://www.iwiet.open.co.uk/pp/D.G.F.Rowntree/>
- Ruberg L.F., Moore D.M. & Taylor C.D. (1996), *Student Participation, Interaction, and Regulation in a Computer-mediated Communication Environment: A Qualitative Study*. Journal of Educational Computing Research, 14 (3): 243-266.
- Rumble G. (1997), *The Cost and Economics of Open and Distance Learning*, London, Kogan.
- Ryan S., Scott B., Freeman H. & Patel D. (1999), *The Virtual University: The Internet and Resource Based Learning* (The Open and Distance Learning Series). London, Kogan Page.
- Salmon G. (1998), *Developing learning through effective online moderation*. Active Learning, 9, dicembre 1998, pp. 3-8.

- Sandelands E. (1998), *Developing a Robust Model of the Virtual Corporate University*. «Journal of Knowledge Management», 1(3). On the Internet, <http://www.freepress.com/journals/gajal/articles/>
- Sandelands E. (1999), *Cyber Tutoring and Learning: How to Facilitate Action Learning Online*. On the Internet, <http://www.mcb.co.uk/imc/news/academic/cybertutoring.html>
- Scardamalia M. & Bereiter C. (1993-1994), *Computer Support for Knowledge-Building Communities*, The Journal of Learning Sciences, Special Issue: *Computer Support for Collaborative learning* III, 3, L.E.A., Erlbaum, Hillsdale, NJ, pp. 265-283.
- Scardamalia M. & Bereiter C. (1996), *Engaging students in a knowledge society*. Educational Leadership, 54 (3): 6-10.
- Schank, R.C. (1997), *Virtual Learning: A Revolutionary Approach to Building a Highly Skilled Workforce*. New York, McGraw-Hill.
- Schreiber D.A. & Berge Z.L. (1998), *Distance Training: How Innovative Organizations are Using Technology to Maximize Learning and Meet Business Objectives*. San Francisco, CA, Jossey-Bass.
- Schutte J.D. (1996), *Virtual Teaching in Higher Education: the new Intellectual Superhighway or just Another Traffic Jam?* California State University. On the Internet, <http://www.csun.edu/sociology/>
- Shepherd C. (2000a), *Evaluating Online Learning* Fastrak Consulting. On the Internet, <http://www.fastrak-consulting.co.uk>
- Shepherd C. (2000b), *The Real Time Online Tutor*. Fastrak Consulting. On the Internet, <http://www.fastrak-consulting.co.uk>
- Shepherd C. (2000c), *The Asynchronous Online Tutor*. Fastrak Consulting. On the Internet, <http://www.fastrak-consulting.co.uk>
- Simoff S. (2000), *Monitoring and Evaluation in Collaborative Learning Environments*. On the Internet, <http://kn.cilt.org/cscl99/A83/>
- Smith M. (1999), *Voices from the WELL: The Logic of the Virtual Commons*. On the Internet, <http://www.sscnet.ucla.edu/soc/csoc/virtcomm.htm>
- Smith M.A. & Kollock P. (1999), *Communities in Cyberspace*, London and New York, Routledge.
- Spiro R., Feltovich P.J., Jacobson M.J. & Coulson R.L. (1995), *Cognitive Flexibility, Constructivism and Hypertext: Random Access Instruction for Advanced Knowledge Acquisition in Ill-Structured Domains*, in Steffe L.P., Gale J., pp. 85-107.
- Stahlke H. & Nyce J. (1996), *Reengineering Higher Education: Reinventing Teaching and Learning*, Cause/Effect, 19(4): 44-51. On the Internet, <http://www.edu-cause.edu/ir/library/html/cem9649.html>
- Stathakos J. & Davie L. (2000), *Learning Partnerships in the Online Classroom: a Collaborative Design Model*. OISE. On the Internet, <http://fcis.oise.utoronto.ca/~ldavie/papers/>
- Steeple, C. (1993). *A Computer-mediated Learning Environment for Adult Learners: Supporting Collaboration and Self-direction*, Journal of Educational Multimedia and Hypermedia, 2(4): 443-454.
- Swigger K.M., Brazile R., Lopez V. & Livingston A. (1997), *The Virtual Collaborative University*, Computers & Education, 29 (2-3): 55-61.

- Tait A. & Mills R. (1999), *The Convergence of Distance and Conventional Education: Patterns of Flexibility for the Individual Learner*, London and New York, Routledge.
- Teare R., Davies D. & Sandelands, E. (1999), *The Virtual University: An Action Paradigm and Process for Workplace Learning* London, Cassell Academic.
- Tidwell A. (1999), *The Virtual Agora: Online Ethical Dialogues and Professional Communities*, "First Monday" Peer Reviewed Journal on the Internet, 4, 7. On the Internet, [http://www.firstmonday.dk/issues/issue4\\_7/index.html](http://www.firstmonday.dk/issues/issue4_7/index.html)
- Trentin G. (1998), *Insegnare e apprendere in rete*, Bologna, Zanichelli.
- Trentin G. (1999), *Telematica e formazione a distanza, il caso Polaris*, Milano, Angeli.
- Turkle S. (1997), *Life on the Screen. Identity in the Age of the Internet*, New York, Simon & Schuster, 1996. Ed. it. *La vita sullo schermo. Nuove identità e relazioni sociali nell'epoca di Internet*, Milano, Apogeo.
- Turoff M. (1995), *Designing a Virtual Classroom*, International Conference on Computer Assisted Instruction ICCAI 95, Taiwan. On the Internet, <http://www.shss.montclair.edu/useful/design.html>
- Turoff M. (1996), *Costs for the Development of a Virtual University*. On the Internet, <http://eies.mijt.edu/~turoff/Papers/>
- Twigg C.A. (1999), *Improving Learning & Reducing Costs: Redesigning Large-Enrollment Courses*. Center for Academic Transformation, Rensselaer Polytechnic Institute. On the Internet, URL: <http://www.center.rpi.edu>
- Veltman K. (1993), *The Electronic Highway and Education: New Doors to keep Open*, Learntec 93, Europäischer Kongress für Bildungstechnologie und betriebliche Bildung, Tagungsband, ed. Uwe Beck, Winfried Sommer, Berlin, Springer Verlag, pp. 423-434. On the Internet, <http://www.sumscorp.com/articles/art11.htm>
- Veltman K. (1997), *New Roles for Education through the Internet*, INET '97 Conference, Kuala Lumpur. On the Internet, <http://www.sumscorp.com/articles/art31.htm>
- Veltman K. (1998), *New Media and Transformations in Knowledge*, Metadata und die Transformation des Wissens, Aspekte der Wissensvermittlung in Kunst, Kultur und Technologie, Heinz Nixdorf Museums Forum, Paderborn, September 1998. On the Internet, <http://www.sumscorp.com/articles/art52.htm>
- Visser J. (1999), *Learning Together in an Environment of Shared Resources: Challenges on the Horizon of the Year 2020*, Report per l'Unesco, Horizon programme 2020. On the Internet, <http://www.unesco.org>
- Wallace P. (1999), *The Psychology of the Internet*, Cambridge, University Press. Ed. it. *La psicologia di Internet*, Milano, Raffaello Cortina, 2000.
- Warschauer M. (1997), *Computer-Mediated Collaborative Learning: Theory and Practice*. Modern Language Journal, 81(3): 470-481.
- Watts R. (1998), *Re-engineering the Learning Process*. Report per The Mark Fresko Consulting. On the Internet, <http://www.ukoln.ac.uk/services/papers/bl/blri078/content/>
- White K.W. & Weight B. (1999), *The Online Teaching Guide: an Handbook of Attitudes, Strategies, and Techniques for the Virtual Classroom*, Needham Heights, MA, Allyn and Bacon, Inc.

- Whittington C.D. & Sclater N. (1998), *A Virtual University Model*. Strathford University. On the Internet, <http://cvu.strath.ac.uk/admin/cvudocs/webnet98/vus.html>
- Wilson B. & Lowry M. (2000), *Constructivist Learning on the Web*. On the Internet, [http://ceo.cudenver.edu/~brent\\_wilson/WebLearning.html](http://ceo.cudenver.edu/~brent_wilson/WebLearning.html)
- Woodall C. (1999), *Becoming an Online Instructor*. IMG University Online. On the Internet, <http://www.imguniversity.com/sawyer/news/imgunews/>
- Zolla E. (1992), *Uscite dal mondo*, Milano, Adelphi.
- Zorfass J., Remz A., Gold. J., Ethier D. & Corley P., (1998), *Strategies to Ensure that Online Facilitators are Successful*. Education Development Center. On the Internet, <http://www2.edc.org/NCIP/>



# INTERNET AS A SUPPORT TOOL IN FACE-TO-FACE TEACHING

Giovanni Bonaiuti  
e-mail: gbonaiuti@unifi.it

## Introduction

Will the university of the future be “virtual”? To what extent will technology replace classrooms? And through which procedures will this change take place? At present there are no certain answers to these questions.

In many cases innovations within universities have developed as a consequence of strategies and planning designed by those at the top. Technological interventions of this type, which are the outcome of precise organisational planning, are at the basis of many of the technological solutions that characterise the present University. But alongside these are other forms of institutional technological innovation, generated so to speak from the bottom, which are largely less predictable: the individual actors within the university (teachers, administrators) are only partially willing to identify themselves in the great projects defined by top management: they themselves have a personal and active relationship with the technologies involved. What thus emerges is a dense mass of specific areas and experiences, which is undoubtedly confused and chaotic, but is nevertheless anchored to concrete needs. I plan to tackle this argument by starting from the protagonists, the teacher and the student, whose behaviour often reveals unpredictable features.

How do teachers react to technological innovation? What spaces, environments and technological tools are they learning to master? How has teaching practice changed in this respect? What new face-to-face/distance hybrids are being created? In this study I plan to examine the prospective ways and means for changes in the university originating ‘from the bottom’, that is from the existing teaching practices, and for the progressive evolution and integration of these within the new technologies.

## The evolution of face-to-face teaching

Before entering into the specifics of solutions aimed at the direct improvement of teaching through technology, it has to be acknowledged that at present almost all western universities have already obtained major results in the simplification of access to administrative information and in the automation of management procedures. Much of such automation, designed to rationalise and speed up the procedural flow, has succeeded in freeing energies and resources, with positive implications which spread even to the sphere of the educational processes. For example, many Universities have activated online services to carry out administrative procedures (from the payment of registration fees to the visualisation of personal and curricular data), and have also introduced telematic systems for exam registrations or book lending services in the libraries, with undeniable savings in time for today’s students (time that can be spent attending lessons or studying) as compared to their equivalents of ten years ago. Entering into the specific sphere of education, we can appreciate how the new *information* and *communication* technology (ICT) makes avail-

able a series of specific tools which contribute to change ways of teaching and learning, in the first place reducing, for both teachers and students, the time required to access the materials and the information, thus lightening their respective work loads and configuring the areas of communication and collaboration between them in a different way. Probably the most interesting impact on “traditional teaching” is that which the individual structures (laboratories, teachers, researchers) are able to produce directly through a specific and creative use of the technologies. Spontaneous and autonomous forms of exploitation of the network for the improvement of teaching effectively represent an extremely vast area of possibilities, which can be analysed and described only in part.

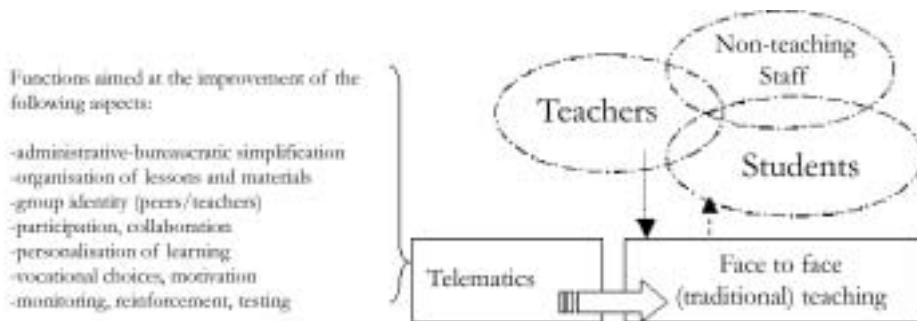

Fig. 1. Diagram showing the potential benefits offered by the technologies to the traditional educational system based on classroom lessons

Fig. 1 illustrates some of the potential benefits that technology can bring to the various activities of the traditional educational system based on the classroom lesson.

A wide variety of *technological devices* can be introduced into face-to-face teaching, to back up the traditional modes of participating in the educational event, and to help simplify and improve the teaching and learning process. Among these are functions which lighten and rationalise the teacher’s task (for example, in terms of the possibility of accessing resources) with a consequent improvement in the organisation of the lessons and materials (since online logic, like that of hypertexts, leads to a greater modularization of the arguments). Other functions relate to the possibility of a greater personalisation of the contents and of student support, at the same time enabling differentiation and integration (see for example the bulletin boards, the FAQ, the self-assessment tests or the integrated learning environments which can be realised on the Web). It should be added that, from a pedagogical point of view, the network, as a result of the “open” and democratic structure which has accompanied its development and dictated its success, is *structurally* in line with a modern view of education that establishes the centrality of the learner and the uniqueness of his/her capacity to build meanings, and that identifies the historical and social context as the sphere in which the production and acquisition of knowledge takes

place. The network itself is prefigured as a *real social context* in which, for example, it is possible to establish areas where, through the collaboration between learners, the dynamics of a *co-operative construction of knowledge*<sup>1</sup> can be realised. The practical application of this principle can be found in the canonical approach of *third generation*<sup>2</sup> distance education (FaD) (Trentin 1998, 1999). This type of experience enhances the natural tendency of the network to facilitate the relations between learners, and at the same time to shift the teachers' role towards the management of stimuli and regulation of the rhythms and modes of learning among peers (Calvani & Rotta 2000). The "added value" of ICT for traditional face-to-face teaching consists, among other things, in precisely this potential of facilitating the evolution towards a more flexible model where the learning may be more widely distributed within the group, through forms such as those mentioned by Rotta elsewhere in this book (greater involvement of learners, increased curiosity, reciprocal teaching etc.). In other words, as we will see in greater detail further on, the technologies give new impetus to the improvement of various aspects characterising the relational experiences between teachers and students, and also within each of the respective categories.

In Italy there have been numerous experiences of the integration of technology into traditional educational activities but these are generally considered *extensions* of the activities of the protagonists of the educational process (teachers/students) without ever becoming *indispensable*. The reason for this soft-peddalling introduction of technology into traditional teaching can be traced to the experimental character of many of these initiatives, which are often the result of the intuition of individual teachers, or the experiences of restricted groups within departments or research laboratories. Only sporadically do such initiatives originate from the top levels of the Faculty Boards, but even in these cases the general idea is to provide support tools which do not discriminate against those students who are not yet in a position to access online resources. In section 3 we provide examples of several experiments carried out within the framework of the Faculty of Educational Sciences of the University of Florence. Similar experiments are increasingly taking place elsewhere, to the extent that it is difficult to document them without the risk of unfair discrimination<sup>3</sup>.

---

<sup>1</sup> It is particular within constructivism that the learning technologies have proved effective. See as an example the studies on the *learning community* (Brown & Campione, 1990; Ligorio, 1994) and of *cognitive apprenticeship* (Collins et al., 1995)

<sup>2</sup> The third generation differs from the two previous ones for the communicative and collaborative approach among subjects, which was made possible by the networks as opposed to the mono-directional distributive approach (from teacher to students) in providing notions and materials allowed by past technology (from the mail to television)

<sup>3</sup> In Italy, of major interest are for example the teaching support to the Course of "Communication Sociology" by Prof. Franco Fileni of the University of Trieste ([www.lscmt.univ.trieste.it](http://www.lscmt.univ.trieste.it)) and the Project Urbana within the Course of "Urban Sociology" by Prof. Guido Martinotti. See also the various projects developed by the Centro METID of the Politecnico of Milan ([www.metid.polimi.it](http://www.metid.polimi.it)); the courses within the "Course of Methodology of Social Research" by Prof. Renato Grimaldi of the University of Turin; the activities of "Leda: Learning Environment for Distance Autotraining", also at the University of Turin ([www.cisi.unito.it](http://www.cisi.unito.it)); furthermore, the various "Online courses" promoted by the CEPAD of the Università Cattolica of Milan



*Tools which extend the activities of the two protagonists*

Unless specific distance learning courses are activated at an institutional level, the use of telematics in university education is normally viewed as an accessory (and therefore optional) support to the traditional forms of access to the services offered. While, on the one hand, this fact has hindered the complete development of the former (with the obligation to guarantee traditional access to the various activities in any case), on the other it has allowed a certain freedom in the setting-up of the experiences and in the experimentation of different forms. Today, on the Internet sites of Universities throughout the world, there is a range of online services presented as optional, or in support of traditional face-to-face activities. Such areas offer a bit of everything: fragments of courses (filmed or otherwise), texts of lessons, electronic bulletin boards and libraries. Many of these initiatives, especially when not the result of precise planning, are characterised by a lack of continuity, reliability or efficiency; in spite of this they enable us to realize the existence of vast application areas which may become increasingly more central to the composition of the residential educational offer of the future. The attempt to make a census of the wide range of online services is an arduous task; there is no doubt, however, that most of these products can be seen as comprised within the two extremes: the extension of the teachers' role and the broadening of the opportunities available to students.

In the first case, there are functions that help teachers to perform their work as best as possible, while also reducing the time normally spent meeting requirements of a technical, logistical and organisational nature. In the second, the technology attempts to meet the students' requirements, providing them with areas for socialisation, *reciprocal-teaching*, *self-help* or simply for entertainment and hobbies. In both cases we are in the presence of supports which are proposed rather than imposed upon the two protagonists of the system.

*Technology supporting the teachers*

Bearing in mind that the areas of intervention of every university teacher are at least three, that is research, teaching and management, the technology can be employed in each of these fields to support and facilitate performance.

In the sphere of research, the telematic network provides in the first place the instruments for access to information (databases, bibliographic resources, indexes, metadata, publications etc.) Secondly, the teacher also has the opportunity to interact with his/her colleagues, reproducing in virtual key a version of the medieval "community of sages". The teacher who participates through the network in these *communities of practices*, improves the processes of knowledge socialisation and contributes to the creation of a "distributed knowledge base". At the same time, through dialogue and confrontation with colleagues (even from different countries) the teachers succeed in acquiring a deeper awareness of their professional identity.

A potential which is emerging in the world of electronic publishing, in support of scientific research, are the instruments offered to teachers and researchers for the composition and management of the entire life cycle of scientific information (from pre-prints

editing to peer-review and publication). It is conceivable that the use of these tools will very soon lead to a different relationship between author and reader, or between the author and other authors and reviewers, transforming scientific documents into open products, although protected by the copyright from the pre-publication phase. Works and studies stored in electronic form are effectively characterised by the potential for connection and integration with comments, contributions and other works present on the network, thus enabling a broader and more fruitful exploitation.

The contribution of technology to the “practice” of *teaching* is probably the most striking aspect, the one in which the external visibility of initiatives plays a major role. Here, the teacher who decides to apply the technology has a quick return in terms of consensus (appreciation or refusal). The tools that are immediately available are those that essentially utilise online communication for a more rapid distribution of information. A significant part of the work of university teachers, from the initial reception of students to the preparation of examinations, is devoted to the explanation of the institutional *framework* within which learners have to move: the elucidation of procedures, the provision of information about times and places of lessons, the supply of bibliographical lists and explanations about how exams are conducted. By shifting online some of these activities (for example, the students’ reception, information on how the courses are organised and how examinations are conducted) along with the development of activities aimed at facilitating learning (elaboration of the arguments dealt with, answers to questions etc.) the services offered to students can be considerably improved, while at the same time lightening the teacher’s workload. Thanks to the possibility of creating online public areas in which knowledge can grow and be stored, the teachers can avoid repetitive activities such as having to repeat the same information to many different learners. In the sphere of British research the term “skywriting” is employed with reference to the use of “multiple reciprocal electronic messages” at the service of academic discussion (Light & Colbourn, 1997, p. 50). The basic concept is that electronic mail (but we could extend the concept to all CMC tools) adds to the advantages of a written, and therefore permanent, form of language the advantages of speed and the possibility of reaching a number of addressees, transforming the interaction among individuals into a sort of symposium or debate (ibid. p. 50). Taking as an example the practice of the *students’ reception*, once the custom of its performance online is established (Web-forum) it is clear that the questions posed by a group of students, together with the teacher’s answers, will remain public for an indefinite time, thus extending the debate to a much vaster public. This will enable a kind of “observer” learning, that is it will give every student the chance to capitalise on the advice offered by the teacher in reply to other students’ requests. Furthermore, when the teacher “personalises” the teaching (for example by replying in a specific manner to a particular request) he/she once again makes available to all a more detailed explanation, which each student can draw on further in his or her own way. The network, therefore, can store course texts, lesson summaries and advanced search channels, just as it can also offer instruments for previewing and focalisation and self-assessment tools (both incoming and outgoing) etc. An additional possibility offered by the ICT, illustrated in the description of a real experience in the section *Collaborative and co-operative environments*) is represented by

the opportunity of providing a collaborative support for the more thorough elaboration of a specific subject. All of these aids, without eliminating the traditional classroom les-

PHASE	FUNCTION	UTILISABLE TOOL	
Teaching Work aimed at the students	Pre-course	Explanation of educational objectives	Online students' guide Teacher's personal Web pages
		Assessment of prerequisites	Informative pages on access modes Interactive self-assessment tests
		Course presentation	Informative pages on lesson organisation, reference bibliography, times and places of lessons, list of seminars and workshops
	During course	Online lessons	Pages with materials that can be downloaded and used from "home": -summaries of contents; -enclosures, text and audio of lessons; -additional materials for elaboration, clarification or exercises; -links to other Internet sites
		Online during lessons	Web pages used during the lessons both directly (with video-projectors) and indirectly as aids in lesson preparation
		Follow-up at end of lessons	F/AQ (Frequently asked questions). The bulletin board shows the replies to questions
		Reception	E-mail (for specific or personal questions)/Web-forum/bulletin board (for public replies)
	After course	Notices and information	Web pages with information on any changes in lesson times, absences, holidays, breaks. Information on forthcoming seminars, meetings and conferences on the subjects dealt with
		Preparation assessment	Informative pages on how the examinations will be carried out; interactive self-assessment tests. After the exams, possible online answers to the written
		Examination sessions	Information on times and places, distance registration; list of enrolled students and <i>assessable</i> ; information about changes in times
Vocational research and studies	Course evaluation	Students are asked to fill in interactive forms to assist in the preparation of lessons for the follow-	
	Research, updating	Web for research and updating: -Bibliographic and catalogic resources; -Access to indexes, metadata, publications; -Thematic Information Pages, Specialised Web-forums; E-mails to authors, editors, collaborators	
	Scientific production	Online elaboration of pre-prints, electronic and traditional publications, materials; participation in virtual clubs of authors and reviewers involved in the processes of preparation, peer-reviewing, integration and management of the publications	
	Structuring of the "community of sages"	Web-Forum for online co-operation through Web-forums or structured Web areas: socialisation of experiences, log- books, materials, reports, etc. E-mail for communication and work organisation	
	Organisation of non-teaching events	Various tools (Web, mail, forums, chats) for the organisation of conference addresses, editing of articles, publications, professional collaborations, etc.	
Academic career	Access to information on Web spaces and roles for democratic participation in elective bodies and the award of chairs		

Management	Bureaucratic procedures (activities' accounting, reports of educational experiences and examinations, etc.)
	Connections to internal structures and personnel (tools for the organisation of the activities, access to the records databases, tools for the organisation of initiatives, events and conventions, collective works aimed at the organisation of teaching, the definition of the credit system, etc.)
	Connections with other national and foreign universities (participation online in the definition of European programmes, support to students engaged in activities of international exchange (Erasmus, Socrates, etc.) standardisation of international examinations, etc.)

sons, offer the students wider prospects in the structuring of their training, and in the selection of appropriate study strategies based on their individual cognitive style.

Finally in the sphere of *management*, the teachers will be able to utilise in various ways the tools permitting access to the definition of university life, not only in the bureaucratic procedures of certification, accounting and reporting of the activities performed, but also in the planning and organisation of meetings and seminars, activities of institutional co-ordination and the implementation of synergies and collaborations with other European and international entities. In all such activities the use of electronic mail, databases and Web conferences has become indispensable.

The characteristic features of the teacher's activities and the specific aids offered by the network are summarised, without pretensions to completeness, in the following table. The picture outlined should be sufficient to give an idea of how, even in the absence of extreme choices, for example in the direction of FaD, the teacher's work will increasingly be structured – and to a large extent performed – online.

#### *Technology supporting the students' needs*

At the other 'extreme' as presented here, the technologies are used to support the group of students. In this case the telematic areas can be provided by the university or by private institutions; there are in fact many specialised sites and portals set up for this purpose by groups of students, associations or (more often) private companies. In conceptual terms, here we enter the sphere traditionally represented by the Faculty corridors, libraries, courtyards and gardens where students meet to study and exchange information. Anyone who has even briefly attended a university cannot fail to remember how precious these moments are for purposes of study. What is involved is the exchange of experiences, suggestions and useful tips, but also the offer and receipt of practical assistance, for example in clarifying difficult points, or borrowing or lending notes. Aspects which are far from marginal in this respect are the chance of retrieving the material of a missed lesson – or a lesson that was not perfectly understood – and consequently of adjusting study times in a personalised manner. If the space for such activities is offered online the effect is one of amplification - intervention on the same subject from a number of directions - and an extension of the temporal availability of materials (permanence) which can indirectly reduce the phenomenon of dispersion and drop-out among students who are unable to keep up with the pace of the lessons.

In addition to this, peer encounter allows the setting up of strategies aimed at unveiling what, in pedagogical research, is called the *hidden curriculum*. Through the exchange of opinions the students try to understand whether the professor, possibly

unconsciously, is pursuing objectives which differ from the official, giving importance to aspects not explicitly included among the course objectives and which emerge regularly during the examinations. What the students have to do is identify arguments which may reveal the teacher's particular interests, weaknesses or recurrent obsessions etc. In this way, the students can lay the cards on the table, and can communicate to each other what, in essence, the teacher wants to hear in the course of oral exam. This aspect of the work involved in all teaching experiences will probably not pass online into the official university sites, but the chance for teachers to "eavesdrop" in these communication



Fig. 2. Discussion forum on "University Reform", University of Padua Internet site

Fig. 3. Web portal managed by the students, University of Cassino

areas could be extremely useful in helping them to focalise their own methods of working and refine the strategies.

In general, the dialogue areas made available to students on the universities' Internet sites can contribute to democratic participation and to the definition of strategies to improve the services offered. The network gives students the chance to let their ideas be heard, to complain about problems, to suggest improvements and corrective measures. The confrontation with the teachers, the tutors and the entire staff through CMC can take place in the form of a free and open discussion, thanks to mechanisms of de-individualisation, re-definition of the context and the reduction (or equalisation) of social differences (Paccagnella, 2000) so that for everyone the expression of opinions becomes less embarrassing and binding.

Examples of public forums opened by the universities on the Web are by now a consolidated practice<sup>4</sup> (in Figs 2 and 3 respectively: the discussion forum on "University reform" opened on the Internet site of the University of Padua, and the Web portal managed by the students in the University of Cassino). What have proved to be even more

<sup>4</sup> Among the Italian University websites that students have at their disposal, we can find: [www.unicastudenti.it](http://www.unicastudenti.it) (University of Cassino), <http://student.gelso.unitn.it> (University of Trento), [www.poli.studenti.to.it](http://www.poli.studenti.to.it) (Politecnico of Turin), [www.studenti-vercelli.net](http://www.studenti-vercelli.net) (Politecnico of Turin (II), Vercelli)

useful are the specific forums linked to a particular theme or even to each individual discipline. Forums that are too generic, especially when not moderated, frequently prove to be dissipated and lacking in character, and in consequence attract a poor “attendance”.

PHASE	FUNCTION	UTILISABLE TOOLS	
Private Time	Orientation, elaboration, recovery	<ul style="list-style-type: none"> <li>-environments for orientation both on entrance (to studies) and exit (job market)</li> <li>-co-operative areas for the exchange of experiences and materials, electronic mail and mailing lists between peers or within groups sharing interests and studies on disciplines of particular interest (advanced research) or where they have encountered difficulties (recovery);</li> <li>-learning of foreign languages (also through idomatic contacts with foreign students and structures), study of related topics and study aids (mnemonic techniques, psycholinguistics, relaxation etc.)</li> <li>- online “self-help” areas</li> <li>- Web sites of private companies for exam preparation (CEPL, etc.)</li> </ul>	
	Entertainment, sports, music, theatre, social, political and religious activities and alternative culture	<ul style="list-style-type: none"> <li>Web sites and Internet tools relating to:               <ul style="list-style-type: none"> <li>-unions, students associations, political parties, ecological and religious movements</li> <li>-information on events (discotheques, cinemas, theatres, meeting places etc.)</li> <li>-Sell &amp; Buy, messages (accommodation/partner searches, sales/ purchases of objects, holidays, etc.)</li> <li>-information on job opportunities</li> </ul> </li> </ul>	
Formal Education Time	Before Course	<ul style="list-style-type: none"> <li>-Web spaces where student associations present the services available and communicate times and places of meeting;</li> <li>-preparation of study plans, choice of subjects on the basis of information taken from official information sites (of the university Faculties) and from tips passed on by older students.</li> </ul>	
	During Course	Support for individual lessons	<ul style="list-style-type: none"> <li>-e-mails between individual students;</li> <li>-mailing lists among specific groups;</li> <li>-Web-forams/bulletin boards as places for the “construction of shared knowledge”;</li> <li>-doubts, questions, replies, attachments, additional bibliographic references, links to other sites.</li> </ul>
		Cafés	<ul style="list-style-type: none"> <li>-Web spaces for encounters, leisure, acquaintance, knowledge and socialisation;</li> <li>-bulletin boards for the advertising of events and shows, even those not “relevant” to the university</li> </ul>
After Course	Support for exams and theses	<ul style="list-style-type: none"> <li>- institutional Web areas for exam guidance (usually edited by the individual teachers);</li> <li>-FAQ in undergraduate ones with the “most frequently asked” exam questions;</li> <li>-Web-forams with strategies and suggestions for the preparation of examinations and theses;</li> <li>- areas of support for the preparation of reports, theses and papers; bibliographies, indexes, abstracts and references.</li> </ul>	

The University study years are also characterised by free time. Here the online context offers information and interactive tools for support and exchange for a whole host of varied activities (voluntary work, sports, clubs, politics, leisure and work).

It is difficult to propose a complete list of the online resources aimed at the requirements of students. The youth target is highly attractive to numerous internet companies, and it is a field where initiatives are multiplying at a fantastic rate. In Italy for example there are much-frequented sites specialised in the exchange of information on room and flat rental ([www.postoletto.com](http://www.postoletto.com)) or for the sale of second-hand books and objects ([www.testiusati.com](http://www.testiusati.com), [www.bachecaonline.it](http://www.bachecaonline.it), [www.bakeka.web.com](http://www.bakeka.web.com), [www.bid.it](http://www.bid.it)) but, also for the exchange of notes or help ([www.appuntionline.tsx.org](http://www.appuntionline.tsx.org), [www.helpscuola.net](http://www.helpscuola.net)) or tips on how to combine study and work ([www.universitaelavoro.it](http://www.universitaelavoro.it)). On a more academic note, there are sites specialised in the distribution of theses, indexes and bibliographies ([www.tesionline.it](http://www.tesionline.it), [www.guide.supereva.it](http://www.guide.supereva.it) in the section “education and training”).

Also worth mentioning are more general sites which touch on all these arguments, from study aid to entertainment, such as: [www.studenti.it](http://www.studenti.it), [www.university.it](http://www.university.it), [www.fuori-corso.it](http://www.fuori-corso.it), [www.icicampus.it](http://www.icicampus.it), [www.sussidiario.it](http://www.sussidiario.it) and [www.corriereuniv.it](http://www.corriereuniv.it). Finally, there is the growing phenomenon of private institutions working side by side with the university with their own educational offer largely aimed at the preparation of university examinations. The teaching and tutorial systems of these companies make use of telematics to reach the students, offering personalised and guided itineraries in those instances where the official structures cannot or do not wish to do so. Many of the clients of such companies are adults or student-workers who cannot follow the official courses, and in some cases are people who live at a distance from the university campus. In any case, the phenomenon has to be assessed for what it is, that is as a market ready to pay even significant amounts of money in exchange for study help. The tools used online by such companies are those typical of the third generation FaD: environments where the private tutors can meet the students and assist them in their studies<sup>5</sup>.

To sum up, for the students too, we attempt to outline the functions which can be usefully performed online.

### **A few examples of teaching support environments**

As we have seen, the objects generated in the process of “technological prosthesis” – that is the prolongation of the functions of the entities participating in the life of the university – can feature varied characteristics, and aspects with different relevance, inclinations and specifications. General trends, as also emerged within the telematic services of the Faculty of Educational Sciences of the University of Florence (a few examples from which will be provided in this section) identify the setting up of at least three different types of *environments* for an unobtrusive, complementary and non invasive “support” to traditional teaching:

---

<sup>5</sup> CEPU, one of the main Italian realities in this respect, supplies three types of services: the vocational advice service for the choice of the University faculty, the preparation of exams of every Italian faculty and bureaucratic and administrative procedures. Many services are found directly at the Internet address: [www.cepu.it](http://www.cepu.it)

- environments for sharing resources and experiences (information and relational spaces, research networks, areas for the presentation of works and study support);
- integrated-distributed environments for the expansion of face-to-face teaching;
- collaborative and co-operative environments (supporting common practice, development of group identity, for distance work).

In the Florentine experience the projects involved were launched thanks to local or national research funding aimed at the study of innovative teaching initiatives and the experimentation of the new technologies in education. The changes in progress in the university system, with the definition of new degrees and the changes in the system of credits, are moreover calling for a significant restructuring of the traditional educational practices in the direction of more flexible and personalised models. Here the technologies can balance conceptually contrasting options, such as developing assisted and personalised forms of teaching and lightening the teacher's workload, within the context of an increasingly mass education. Wherever the assisted and personalised teaching requires investments and increased workloads for the teachers, the technologies, through the features identified above, provide the solution for redistributing the workload over more extended groups (teachers, tutors both internal and external, students etc.). Often these are environments which start off from an initial design and featuring certain structural limitations, which are then opened up to the intervention of the users, thus becoming places that develop autonomously in directions that are only partially pre-established. The experiences that will be described can therefore, in accordance with these premises, be fitted within the three specified categories:

The first case (*environments for sharing resources and experiences*) relates to an informative and relational space linked to a network of teachers and experts dealing with a specific topic: research on educational technology.

In the second case (*integrated-distributed environments*) the technologies are structured to extend and prolong the teaching experiences and supports beyond the limitations of face-to-face experiences. Here, through a kit of tools integrated with the telematic services of the Faculties, the teachers can set up their own environments of online assisted teaching.

In the last case (*collaborative and co-operative environments*) we are dealing with two different uses of technology for co-operative purposes, that is to stimulate the bonding of group identity and to promote communication and practices of work or study among individuals. In the first case the objective is distance co-operation among groups of students belonging to two different universities, in the second the technology supports a group of tutors in the variegated relationships that characterise their work.

#### *Environments for sharing resources and experiences*

This first environment shows one of the most classic uses of the network as a place for the collection of materials and the connection of individuals. However, the range of this type of tool should not be underestimated. Well-designed environments lend them-



selves to becoming “generative” sites, both in the sense that they can give rise to incremental forms of aggregation, and in that their own evolution ends up by becoming autonomous and progressive. The project was launched as a support to the activities of the University of Florence Educational Technologies Workshop<sup>6</sup> (LTE). Here, a group of teachers and experts involved in studies on educational technologies<sup>7</sup> have the chance to meet, in what has become a veritable online workshop, a place where the studies produced can be diffused, discussed, elaborated and stored. The tools made available by Internet for LTE, therefore, enable the sharing of resources and the facilitation of research. If the main objective of a computer-based support is the conservation and exchange of the experiences and materials produced by the team, the way in which it makes this possible demonstrates a particularly interesting conceptual approach. Every LTE collaborator can autonomously (and with the sole use of the Web browser) keep his/her own area updated and draft specific forms relating to the various arguments treated. In this way, a huge variety of materials will be gathered online (bibliographies, essays, documents, reports, pre-prints etc.) on which the other collaborators can intervene (peer reviewing) and which outside experts and students can get access to. The produced materials, in addition to being stored online and becoming part of the expertise shared by the group, are also at the disposal of all those who apply to the workshop for an elaboration of the topics under study. Among the beneficiaries of these environments there are, of course, the students and undergraduates who can easily access a structured collection of materials and interact with the experts. This opening of the research community towards students’ requirements also provides the latter with access to the methodological and operational processes of the study group, through dynamics which recall the methodological construction of *cognitive apprenticeship* (Collins et al., 1995). The experts, by interacting with the students, enable the gradual approach of the latter to the world of research.

The online workshop is, moreover, the crossroads of a series of relations which involve teachers of different disciplines and Universities; within this there is a materialisation of the idea of knowledge as a process of construction, negotiated and practised in specific historical-social contexts on the guidelines of social and cultural constructivism.

### *Integrated-distributed environments for face-to-face teaching*

The AIDE<sup>8</sup> project was launched within the “teaching innovation initiatives” programme financed by the University of Florence in the course of 2000, and has led to the development of a generator of *interrelated environments in support of teaching* set at the dis-

<sup>6</sup> [www.scform.unifi.it/lte](http://www.scform.unifi.it/lte)

<sup>7</sup> This line of research ranges on two fronts: the *methodological* one concerning the conceptual framework that govern the organization of the instructional process (definition of teaching methods, the models and the curricula, instructional design, etc.) and the one typical of educational environments, that is the physical and technological tools, today mainly communicative and media-based, which are used to implement processes (Calvani, 1999)

<sup>8</sup> The name of the project is an acronym of the functions made available to teachers, that is: ask (as \space for questions of the students’); insert (insertion of informational data); demonstrate (advanced search on one’s own disciplinary ambit, adding references to the resources already present in the network); evaluate (an environment that provides cues to verify what has been learned)

posal of teachers. Through a series of tools, teachers can prepare areas of support and elaboration for all the subjects they teach. These tools allow the teachers a large margin of freedom in the definition of the educational objectives and the subsequent modes of use. In general, this takes place within a framework of modular teaching, where distinct thematic and conceptual sections can be followed by specific – and in this case online – activities and experiences. The technological supports offered to the teachers are not binding in this sense, any more than their utilisation is.

The essential philosophy of the instrumental system offered is that of creating environments which are easy to use for both teachers and students, and which can be immediately exploited through standard products such as the *Web browsers* (Netscape or Explorer) and *electronic mail* programmes (Eudora, Outlook). These environments, integrated with the basic services of the *On-line Student Guide* of the Faculty site<sup>9</sup>, allow the manipulation and visualisation of the information through dynamic interfaces of access to the data, developed within the Internet environment. The *On-line Student Guide* provides information about the teachers and the subjects taught, indicating the times and places of lessons and reception sessions, course contents, educational objectives, bibliographies, activities such as seminars and workshops etc. This information, which is also printed and distributed in paper form, is updated annually and inserted via Web directly in the databases by each of the individual teachers through the use of a personal password. The Secretarial Offices of the various Faculties have the task of supervising the entire process.

Through the AIDE project, for every page regarding a subject taught by the individual teachers, as well as the institutional information about the course set-up, other support tools can be activated containing information and elaboration, fact sheets, self-assessment tests and discussion forums. The teachers therefore have at their disposal tools to operate independently in the following areas:

- maintenance of their own course page (containing the programme as published in the Student's Guide);
- maintenance of a personal page indicating the teacher's curriculum, the sphere of research, his/her own bibliography and links to Internet sites of particular interest, etc.;
- insertion/maintenance of "teaching pages" that is of a – theoretically unlimited – series of subject pages, not necessarily interrelated but which can be serialised, in which the teacher can insert texts or attach files (documents, Powerpoint presentations, graphs, electronic sheets etc.) or cross-reference to Internet links relevant to the subject. These pages can be structured in various ways, and be more or less pertinent to the course. In line with the philosophy of the AIDE project, the teacher is free to use them as he/she thinks best in accordance with his/her own teaching method;
- insertion/maintenance of test forms, which can be either of a multiple choice type, or discursive for the exposition of concepts. Each of these

---

<sup>9</sup> [www.scform.unifi.it](http://www.scform.unifi.it)

forms has space for one question (or for the exposition of a topic) followed by spaces for three different hypotheses of argument. To each of these hypotheses there is a corresponding reply (or counter-argument) which the teacher provides. At the moment of utilisation, the student will therefore see the question and the three hypotheses of argument each of which, when selected, will show the related reply. In the case of a multiple choice test, three possible replies will be placed next to the question of which only one is correct. The choice of one of these will then bring up the text in which the teacher explains the reasons why the reply was right or wrong. The system does not, however, impose this type of utilisation, leaving the teacher free to choose the conceptual reference model and the fields of application. The environment can in fact serve to assess the students' incoming or outgoing levels of learning for a particular course, while it can also be used as a dialogue space in which to elaborate the arguments being dealt with. In this case too, the system makes no limit as to the number of test forms that can be activated by each teacher;

- modulation of the discussion environment, or Web-forum, within which space the teachers can reply to the students' questions (or the students to each other). In this operational ambit the same dynamics emerge that characterise the "students' reception", with questions of an administrative, institutional or logistic nature coming up alongside specific queries about the argument being dealt with, about texts, or about problems that may have arisen in the course of study. As modulator of the Forum, the teacher can also intervene to cancel contributions which are considered inappropriate, or reply in private form (via e-mail) to questions which are not of general interest.

The value of these tools, as can be intuitively understood, lies in the potential for diversified use which, among other things, enables the gradual experimentation of more or less extended periods of FADs. The advantage of laying at the teachers' disposal a single but flexible environment is that it enables the students to save time in becoming familiar with the tools and interfaces, and the organisation to save on the purchase of specialised and diversified platforms.

As has been experimented elsewhere in similar projects undertaken by other Italian universities, such as the experiences developed at the METID centre of Milan Polytechnic, the employment of FAD tools to support face-to-face teaching affects both the administrative-logistic management and the educational relationship between university and student. The result is an improvement in the aspects of: (a) *distribution of teaching materials* (traditional and multimedia); (b) *clarity of communication* (transparency and rapidity of information); (c) *more extensive and enhanced student-teacher interaction* and, (d) *between students*, in addition to the possibility of: (e) *expanding the sources* through the use of the network use to increase potential contacts with entities beyond the University (Colorni & Sancassani, 2000, pp. 79-93).

The use of the technologies to support face-to-face teaching implies *direct effects* such as the ones described above, which can be globally defined as enhanced possibilities of “*collaborative learning*” (co-operative learning)<sup>10</sup> where the individual finds him/herself interacting – as well as with his/her own past experiences – also with the social context. There are, however, also *indirect effects*, such as the chance offered to the teachers to design and organise a more modularised teaching method where the definition of the contents becomes an activity parallel to the setting up of the materials, and where the latter shift progressively from traditional formats (mainly paper and linearly structured) to electronic, hypertextual and interactive formats.

### *Collaborative and co-operative environments*

The last case presented here focuses on the potential use of the technologies alongside traditional teaching to support and facilitate the construction of meaningful links within a community of people (whether they are sharing the experience also through face-to-face activities or are involved solely via distance learning).

Two experiments can be used to illustrate this. The first took place in 1997 among students at the universities of Florence and Padua (Calvani et al., 1997) where Internet was used both to motivate students to participate in seminar work, and to contribute to the definition of a shared co-operative activity between the two distant workgroups. Thus technology served both as a working tool and for creative stimulus. The final task for the two groups of students on the respective degree courses in Educational Sciences was to construct a single Internet site, designed to display a synthesis of the subjects of study which, in the case in question, were related to “constructivism and didactic planning”. The two groups of students never met physically, using only the communication tools made available by Internet (electronic mail, forum, chat, and ftp for the transfer of files). The experience, which has also been the subject of various studies and theses, has allowed teachers and researchers to assess its potential through the monitoring of the dynamics developed, both within the local group and between this and the remote group (cognitive, relational and emotional scaffolding etc.). The research, comprised within a constructivist framework, sees the two groups, the class, as a veritable community (*communities of learners*) where all the protagonists can play the different roles exchanging tasks and responsibilities, all of them being at once apprentices, teachers and scientists (Ligorio, 1998). The learning takes place through the discovery, confrontation and questioning of each individual’s previous knowledge, and can therefore be considered to all effects a social product, the result of both individual effort and community interaction. In this case, the results which the two groups have achieved, in terms of learning and the construction of bonds of identity, enable us to glimpse the potential, which can moreover be realised at a relatively small cost for the university structure. The advantages for the students are pre-

---

<sup>10</sup> “A broad definition of collaborative learning could be the acquisition on the part of individuals of knowledge, skills or attitudes that are the outcome of group interaction, or, said more explicitly, as the individual learning which is the outcome of a group process” (Kayle, 1994). On this topic there is very wide literature. For a more extensive search on cooperative learning as methodological teaching approach, go to the Internet site: [www.kagancooplearn.com](http://www.kagancooplearn.com)

dominantly on the methodological level: learning to work in groups, learning to use the network in a creative way, assessing the limitations and the potential of distance collaboration, while the technological pretext helps to make the subject in question more stimulating.

The second example of an environment of *co-operative learning* is an experiment still in progress within the Degree Course in Primary Education Sciences at the University of Florence<sup>11</sup>. In this case the technology is introduced to improve the internal and external relations of the group of tutors supervising the students' training (consequently: teacher support tools). From the very introduction of these tutorial figures within the course, their role immediately proved to be particularly complex. Effectively, the *supervising tutors* find themselves operating in a highly problematical context, both because the regulations in this field are not explicit, and because they have to interact with a multitude of referents operating within different contexts and with different goals, that is, within a poorly integrated "systemic dimension". The tutors have to organise and manage the training (which the students must carry out), interacting with various scholastic institutions scattered over the regional territory and with which the University stipulates special agreements. The tutors consequently have to navigate their way through an intricate network of relations (secretaries, teachers, students etc.), with an elevated risk of defections and misunderstandings.

Within this context, the technological environment offers an area for co-operation, for the management of the internal activities of the community of tutors, and also a window for information and the co-ordination of all external interaction. The operational tools, in practice an Internet and an Intranet interface<sup>12</sup> directed at the "training system" (Fig. 4), have favoured three principal dimensions: (a) *information*, that is the facilitating and support of training and teaching activities by making available materials, information and tools "online"; (b) *co-operation* areas to support the sharing and creation of "collective knowledge" to be realised in an environment reserved exclusively for the tutors; (c) *management* (mainly bureaucratic and administrative) that is, a whole series of tools which can define and support organisational dynamics. The group of tutors has found in this multi-functional technological support a valid tool for the definition of roles, for consolidating team identity (or the *community of shared practices*<sup>13</sup>) and for facilitating the relations with the other elements in the system.

As highlighted by these two experiences (the groups of students from the two universities, and the tutors supervising the training programmes), the new technologies are at

<sup>11</sup> The experience thus described was coordinated by Prof. Antonio Calvani, in charge of the local research project 40% 1999: "Models and prototypes of multimedia and interactive teaching for the teachers' distance training" (person in charge nationwide: Prof. L. Galliani)

<sup>12</sup> The Internet address is: [www.scform.unifi.it](http://www.scform.unifi.it)

<sup>13</sup> The concept of "communities of practice" (Pontecorvo et al., 1995) has been acknowledged in North American literature especially in the ambit of cultural and organizational psychology and later drawn on by educational sciences to indicate those working groups characterized by informational aggregation around common objectives, with a marked capacity to share knowledge and provided with peculiar modalities of interpretation and socialization if the experiences

once artefacts which can enhance communicative interaction, freeing it from time and space limitations, and tools capable of determining innovative forms of organisation and collaboration. The *network*, therefore, throws up an “area” where the sporadic encounters of individuals engaged in the same activity can be followed up by the sedimentation and continuous re-elaboration of common knowledge, thus becoming a support to the improvement of individual learning and reciprocal assistance. The resulting benefits include both the quality of performance developed, and the levels of satisfaction and self-motivation which the network succeeds in stimulating within the team.

## Conclusions

We have attempted to focus attention on the broad range of applications that develop, often spontaneously, in the specific contexts of use. Alongside the technological solutions designed to solve general problems, in day-to-day life there emerge many modes of use of the network designed to strengthen and expand the activities of individuals involved in the educational system. These tools, adapted in particular to the requirements of teachers and students, allow an expansion of the operational potential thus improving the results of both, while never being presented as exclusive. We are in fact within the context – destined to remain largely such for some time – of a university system which considers the residential model as the fulcrum from which the various educational offerings unwind. Face-to-face teaching, as well as being a model defended by the strength of tradition and by a certain resistance among the various human resources still linked to the *school-class-oral lesson* system (Calvani, 1994, pp. 33-35) also effectively offers, especially in some instances, objective advantages in comparison to the practice of remote, virtual access to instruction. Nevertheless, the advent and availability of the new technologies is bringing about changes which will make it increasingly difficult to refer to the classroom experience as an experience of traditional teaching. Technology, as we have seen, brings innovation to the way in which the lessons are prepared, offering new possibilities for extending and continuing their development after the event, expanding the explication and significance potential beyond limits of time. The ICT tools also enable the setting-up, alongside the traditional meeting places, of online social areas offering original modes of knowledge definition and access (learning communities).

It is undoubtedly likely that in some cases these “innovations” may also end up producing pejorative effects. Technology, *altering* the contexts into which it is introduced, does not necessarily in itself represent the solution to the problems, and nor is its function necessarily a positive one: an uncontrolled introduction of technology could, for example, result in an excessive energy being devoted to the *machine*, to the detriment of more elevated, reflective activities (Calvani, 1999a). Nevertheless, it has to be clarified that the introduction of teaching support technologies within the university context does not imply the same risks of disorientation as within the *teaching setting* of compulsory scholastic education. In the case of Universities, effectively, no single educational experience is exclusive: even the lessons often have the character of *opportunities* which are not indispensable for the purposes of study, which remains the personal and independent responsibility of the student. Within this context, therefore, the technologies are more appropri-

ately represented as further “aids” in the complex scaffolding of set of university tools. In general, however, most of the initiatives in support of *face-to-face teaching* do actually result in the improvement of the specific aspects at which they are aimed: they contribute to alleviate tasks, to simplify access to the resources, to stimulate interest in the subjects of study and to set up or reinforce research groups.

Technology is increasingly present in all sectors of university education but, at least in Italy, we can often observe a marked distinction between initiatives in which the ICT are institutionally comprised and those in which they remain optional. Only distance Degree or Diploma courses, which are offered on the basis of the use of such technologies, require the registering students to be equipped with the tools and skills necessary for access. In other cases, there is an implicit compliance with an “educational contract” presumably drawn up with a traditional, residential context in mind. Furthermore, we also have to take into account the lack of uniformity in terms of the willingness, or capacity, of the teachers to use the technology as well as perform traditional, face-to-face activities. These are among the reasons why many experiments in the introduction of ICT are effectively launched within local circuits, emerging from the specific requirements of teachers who are more sensitive to such opportunities, which have not yet been made available in many structures. The next step, which is already becoming a reality in many Italian universities, is the setting-up on the central servers of integrated environments for the support of face-to-face teaching (like that described in paragraph 3.2). These environments make it possible to fill the gap between available and necessary resources, as observed by Colorni & Sancassani (2000, page 83) by succeeding in eliminating the costs which each teacher would have to bear for the use of innovative tools within his/her own teaching offer<sup>14</sup>. The final scenario, which can reasonably be considered as imminent, is that of a university which can guarantee its students the additional possibility of acceding to or completing their education via the network.

## BIBLIOGRAPHY

- Brown A.L. & Campione J.C. (1990), *Communities of learning and thinking Or a Context by Any Other Name*, Human development, 21: 108-125.
- Calvani A. (1994), *Iperscuola. Tecnologia e futuro dell'educazione*, Padova, Franco Muzzio Editore.
- Calvani A. (1999), *Manuale di tecnologie dell'educazione*, Pisa, ETS.
- Calvani A. (1999a), *I nuovi media nella scuola. Perché, come, quando avvalersene*, Roma, Carrocci Editore.
- Calvani A. & Rotta M. (2000), *Fare formazione On the Internet. Manuale di didattica online*, Trento, Erickson.

---

<sup>14</sup> Here we can signal the activities of the METID center of Milan, of the CESIT in Florence or of the CEPAD at the Cattolica of Milan

- Calvani A., Sorzio P. & Varisco B.M. (1997), *Uno studio esplorativo di apprendimento cooperativo a distanza*, TD, n. 12 - primavera 1997, pp. 27-33.
- Collins A., Brown J.S. & Newman S.E. (1995), *L'apprendistato cognitivo. Per insegnare a leggere scrivere e far di conto*, in Pontecorvo, Ajello, Zucchermaglio, *I contesti sociali dell'apprendimento. Acquisire conoscenze a scuola, nel lavoro, nella vita quotidiana*, Milano, Ambrosiana, pp. 181-231.
- Colorni A. & Sancassani S. (2000), *Esperienze applicative al Politecnico di Milano*, in Biolghini D. & Cengarle M. (eds.), *Net Learning Imparare insieme attraverso la rete*, Milano, ETAS Libri.
- Kaye A. (1994), *Apprendimento collaborativo basato sul computer*, TD, n. 4 - autunno 1994, pp. 9-27.
- Light P. & Colbourn C. (1997), *Verso il cielo: la Comunicazione Mediata da Computer a supporto dei corsi universitari tradizionali*, TD n. 12 - Primavera 1997, pp. 50-55
- Ligorio M.B. (1994), *Community of Learners. Strumenti e metodi per imparare collaborando*, TD, n. 4, autunno 1994, pp. 22-35.
- Ligorio M.B. (1998), *Le Comunità di Apprendimento: tutti apprendisti, tutti insegnanti, tutti scienziati*, in Trentin G., *Didattica in rete: Internet, telematica e cooperazione educativa*, Roma, Garamond. On the Internet, <http://www.bdp.it/iride/polaris/albero/comlearn.html>
- Olimpo G. & Trentin G. (1993), *La telematica nella didattica: come e quando. Un'analisi dei possibili ruoli e significati che la telematica può assumere nei differenti momenti della didattica*, TD, n. 2 - Autunno 1993, pp. 4-17. On the Internet, [http://paradiso.itd.ge.cnr.it/td/td\\_fr.htm](http://paradiso.itd.ge.cnr.it/td/td_fr.htm)
- Paccagnella L. (2000), *La comunicazione al computer*, Milano, Il Mulino.
- Pontecorvo C., Ajello A.M. & Zucchermaglio C. (1995), *I contesti sociali dell'apprendimento. Acquisire conoscenze a scuola, nel lavoro, nella vita quotidiana*, Milano, Ambrosiana.
- Serio L. & Melgrati A. (eds.) (2000), *I sistemi di formazione: modalità di integrazione tra formazione tradizionale e a distanza*, in Mattei M.G., *EduNet. Seminari, incontri e attività di formazione*, Atti dei convegni di SMAU 2000, Milano, [print on demand], pp. 42-47.
- Trentin G. (1998), *Insegnare e apprendere in rete*, Bologna, Zanichelli.
- Trentin G. (1999), *Telematica e formazione a distanza, il caso Polaris*, Milano, Angeli.





**DISTANCE EDUCATION, OPEN LEARNING, AND  
ONLINE EDUCATION:  
AN ANNOTATED BIBLIOGRAPHY**

Edited by Stefania Cecconi

**Open and Distance Learning**

**DESMOND KEEGAN**, *Foundations of Distance Education*. London and New York, Routledge, 1993; Italian translation: *Principi di istruzione a distanza*. Firenze, La Nuova Italia, 1994.

The author has written this book with the explicit intention of summarising the fundamental principles underlying this educational system in a single reference source. This text, which is the result of ten years' research, in addition to offering terminological definitions that are univocal and exhaustive on the subject, synthesises into a single perspective the schools of thought and the historical experiences gathered from numerous international scholars.

Translated in 1994 by La Nuova Italia, the text furnishes a theoretical reference base that is deserving of careful attention, especially in Italy where up to now the subject has been considered as of only secondary importance.

As the title itself suggests through the use of the word foundations, the main principles of the conventional type of distance education are studied in this book: its history, growth and the current typologies.

It is a fundamental text for anyone who wants to read up on the subject.

**DESMOND KEEGAN** (editor), *Theoretical Principles of Distance Education*. London and New York, Routledge, 1993.

Written in collaboration with some of the most important experts on distance education in the world (O. Peters, D R. Garrison, T. Bates, B. Vertecchi, to mention only a few), this text, published in the same year as that above and with a similar title, differs in the way subjects are treated. It could almost be defined as a critical manual on various crucial topics of *distance education* and its development, expansion, and growth (unlike the book described above which has a more theoretical-methodological style). The topics developed are subdivided into educational, academic, analytical, philosophical and technological areas. Everything is reviewed in the light of what seemed to be the new challenge and promise of distance education at that time, marked by the advent of new educational technologies in adult education.

**BORJE HOLMBERG**, *Theory and Practice in Distance Education*. London and New York, Routledge, 1995.

The first edition of this text was published in 1989, but due to the rapid and widespread development of distance education systems in higher education, Holmberg, a

scholar of distance education since 1955 and an expert in the planning and organisation of distance education systems, synthesises in this text some of the most recent theoretical approaches, supported by some significant practical studies carried out during the recent years of vast development. The author underlines the positive role played by the new communication technologies in overcoming the classic problems of “isolation” characteristic of previous systems: the advantages to be gained within the learning process, through greater social interaction between tutor and student, are the key for raising distance education systems to a superior qualitative level.

**STEPHEN BROWN** (ed.), *Open and Distance Learning Case Studies From Industry and Education*. London, Kogan, 1997.

The author illustrates some practical experiences of open and distance learning in two contexts which are at present increasingly interested in this new educational model: universities and large industries.

In these two different types of educational environment a variety of technologies are used; materials are diversified and the educational needs and motivations which bring such courses into being are different (from obtaining a qualification to professional refresher courses).

Within the six industrial and the seven university case studies, the author invites the reader to look for elements which are common and those which are not, stimulating an awareness of the important variables which underlie their realisation. The different cases presented are evidence of a very important cultural change: the passage from the *teacher-centred* model to more flexible forms such as those which privilege an orientation of the *student-centred* type.

**GREVILLE RUMBLE**, *The Cost and Economics of Open and Distance Learning* London, Kogan, 1997.

The management and costs of distance education courses are the “hottest” topics of debate today. More specific knowledge of the strategic planning which can ensure an appropriate level of effectiveness and efficiency is required in the operative choices that must be made.

But what are the economic advantages offered by distance courses, and how are they evaluated in comparison with traditional courses?

How is a distance course planned and managed in relation to the different cost typologies?

To what extent do the initial structural expenses impinge, in relation to the entire life cycle of an education course? How important are the major or minor investments that must be made for the support and monitoring of the educational process in relation to the final quality of the course?

Greville Rumble (manager of the Open University in the United Kingdom and the greatest expert on the subject at international level) answers these questions, offering

effective formulas and indicators for quantifying and evaluating the entity of costs in relation to the pre-established objectives, the restrictions imposed and the available resources.

**ANNIE JEZLGON**, *La formation a distance: enjeux, perspectives et limites de l'individualisation*. Paris and Montreal, L'Hormazzon, 1998.

Today "etre en formation" is no longer a requirement, but rather a way of life, "devient un mode de vie permanent et constitue...un atout d'adaption aux évolutions des entreprises e de la société en général", in what has been defined by many as the knowledge society. In this context, the emerging need is to try to promote teaching-learning experiences which are characterised by the way in which they succeed in valorising and developing the student's progressive autonomy. This is the real challenge thrown up by modern society: the promotion of new modes of acquiring more open and flexible knowledge.

Does distance education, in its various aspects, succeed in answering this new need for individualisation?

What is the correct relationship between autonomy and control in distance education and how can these two terms, which at first glance appear to be diametrically opposed, be reconciled?

Starting from such objectives the author tries to resolve some apparent contradictions, presenting in this book her theory of "autoformation éducative" or "formation autonomisante".

**OTTO PETERS**, *Learning and Teaching in Distance Education*. London, Kogan, 1998.

O. Peters is one of the greatest theoreticians of distance education systems in Europe: his name is associated with his, by now historic, theories of distance education (strictly of the conventional type) such as industrialised education systems.

Today the author is inevitably involved in enriching his initial theories, as a result of the manifest changes and developments which the telematic communication system has brought about in the traditional models of distance education.

The text is undoubtedly valuable in terms of its international perspective, which serves as a background for a detailed analysis of those educational systems commonly called open and distance learning. The two categories of open and distance learning are discussed both individually and in relation to each other.

Worthy of careful consideration are the three cornerstone concepts of the book: the dialogue, the structuring and the degree of autonomy in a distance education course. These three fundamental elements, differently projected and developed in the educational environment referred to, can be useful indicators for an examination of the various models of distance education in existence, as well as providing useful hints for potential future opportunities.

**JUDITH CALDER and ANN McCOLLUM**, *Open and Flexible Learning in Vocational Education and Training* London, Kogan, 1998.

Over the last 25 years there has been a growing need in the sphere of teaching for the adoption and development of approaches to learning characterised by greater openness,

flexibility and spatial-temporal independence. This is all the more striking in the specific context of professional training: today it is calculated that about 70% of all working companies and organisations use the methods of open, flexible and distance learning to enhance the participation and development of their employees as a powerful weapon in the battle of incessant global competition.

Within this context the authors examine some of the most important themes: from the nature of the emerging needs of the user up to the final evaluation, seeking to offer both new gauges of effectiveness and indicators of efficiency which might be used to enhance the development of the education process.

The theoretic framework is complete, and the work is particularly interesting for those operating in the field of professional training.

**FRED LOCKWOOD and COLIN LATCHEM** (eds), *Staff Development in Open and flexible education*. London and New York, Routledge, 1998.

The continuous development of educational systems under the principles of *open and distance learning*, within both institutions and organisations, has created the need for major reflection on the importance of the continuous re-qualification of the teaching staff.

In the first place, it is essential that the teaching staff become fully conscious of the changes in progress: the progressive shift from the predominant perspective of *teacher-centred* to *learning-centred* education demands the acquisition of a new mentality. At a higher level it is also important to develop an institutional culture which promotes a continuous process of refresher courses for the acquisition of the specific skills and/or competencies which the new technological environments require.

The topics dealt with in this text are many and varied (from political and economic factors to various present and future application models), and are undoubtedly of great utility to all those organisations which wish to enact these changes.

**ALAN TAIT and ROGER MILLS** (eds), *The Convergence of Distance and Conventional Education: Patterns of Flexibility for the Individual Learner*. London and New York, Routledge, 1999.

In the sphere of the public and private institutions dedicated to higher education, there is an increasingly felt need to reflect on the changes in progress, in order to respond more usefully to the challenges posed by the online and/or learning society (foremost among them the new strategies of lifelong learning, the advent of telematic technologies and the growth in the educational demand). In this context, the traditional educational models offered by the Universities are no longer adequate for the new demands: a change which opens up new opportunities of flexibility is required.

Today we are witnessing a mingling of old and new educational strategies resulting from the increasingly widespread use of technological education supports: the result of all this is the putting into practice of "mixed" forms which call for a serious rethinking of the initial contradistinction between traditional education and distance education.

The aim of this book is to make the reader reflect on the importance of such a passage and on how to put it efficiently into practice. The Universities, in the first place, are

called upon to gather greater knowledge about the strategic factors which lead to flexibility, since the change to be brought about can never be complete unless, beyond teaching itself, the entire institutional-administrative order is transformed.

The presentation of a case study, the mixed model of several Australian Universities, enriches the debate, furnishing useful indications on how to put this "convergence" into operation.

**KEITH HARRY** (editor), *Higher Education Through Open and Distance Learning*, World review of distance education and open learning series, vol. 11. London and New York, Routledge, 1999.

This first volume of a recent collection entitled *World Review of distance education and open learning* is promoted by the international organisation Commonwealth of Learning, which was founded in 1988 by the Commonwealth of Governments. The aim of this collection is to furnish an international reference point which indicates the status of advancement and development of models of *open and distance learning* applied to higher education.

The author touches upon some of the more important topics in the contemporary teaching scene, such as the need for a greater consideration of educational models which respect the emerging need for a perspective of *lifelong learning* and *flexible learning*, and a more careful consideration of the impact of telecommunications on education and the inevitable changes they bring about in terms of cost. In the second part, he then goes on to present the most significant experiences in the international field of some of the more important distance and/or open universities in the world (distributed over the five continents) characterised by the putting into practice of *open and distance learning* models. Valuable for its rich and unprecedented documentation, the text proposes the hypothesis of a univocal, global institutionalisation of such education systems aimed at eliminating, through a uniform system of credits, any barrier which might limit education at the highest levels.

## Online Education

**LINDA HARASIM** (editor), *Online Education Perspectives on a New Environment*. New York, Praeger, 1990.

This is the first text published in the international field aimed at offering a univocal and exhaustive theoretical treatment of the principles characterising the new and promising pedagogical paradigm known in English as online education. The author, through a careful comparative analysis with the two, by now classical, educational models of face-to-face teaching and conventional distance education, shows how computer mediated communication applied to education environments, brings notable advantages in socio-cognitive terms because of the strong co-operation and participation component which it is able to develop. Contrary to any simplistic transposition of the old pedagogical models, the author instead invites the reader to apply greater critical thought to the manifest contemporary need for more profound reflection and research into this new educational model,

since its peculiarities, problems and potential opportunities for the future have not yet been sufficiently studied.

**LINDA HARASIM and STARR ROXANNE HILTZ**, *Learning Networks: a Field Guide to Teaching on Learning Online*. Cambridge, MIT, 1995.

What does the term learning networks mean? These are not simply computer networks but also all those who use them with advantage during their educational activities, or rather those who, working together in an online environment, create a real learning community through a dialogue-type communication which leads to the sharing of “diffused” knowledge.

Online education produces new and promising educational opportunities: the shift from the traditional practice of teaching-learning towards new forms of strongly interactive communication and largely collaborative didactic practices appears to develop a greater motivation in participants.

The authors are optimistic for the near future, but are also critics alert to the various perils and dangers that must be borne in mind, having written this text with the aim of offering a manual to assist the orientation of all those who want to teach or learn online.

**MARGARET MORABITO**, *Online Distance Education: Historical Perspective and Practical Application*, dissertation presented in 1997 at the American Coastline University. Dissertation.Com, 1999.

When was *online education* born and how does it differ from other systems of distance education? The author answers these questions by surveying the history of online education from its origins down to the most innovative current experiences, such as those of the *Internet-based school*. CALCampus is one of these and is presented as an explicit model of this innovative mode of education.

Founded in the early 1980s with the specific aim of becoming an international learning centre, today this private school makes sole and exclusive use of online as an operative educational base. It is not a University but an education centre which responds to each user's educational needs, whether in the sphere of qualification and/or professional updating, also offering eventual assistance and support for adult higher education studies.

The courses offered cover various disciplines (for example courses in foreign languages or in *educational technology*), many of which are the result of new demands made by the labour market, which are not always adequately met by the educational institutions.

The aim of the book is to make the reader reflect on the revolutionary teaching methods and the future opportunities that online education can offer.

**KEN WHITE and BOB WEIGHT** (eds), *The Online Teaching Guide: a Handbook of Attitudes, Strategies, and Techniques for the Virtual Classroom*. Needham Height, MA, Allyn and Bacon, 1999.

What are the specific skills that an online tutor must acquire?

This is the question to which this book tries to give an answer through the 14 contributions by authoritative members and collaborators of the online campus of Phoenix University.

The basic principle which associates all the essays is that of repeatedly underlining how important it is to recognise that online education is not only a more practical and economic method of distance teaching, but that it must be considered as a new, social, teaching “location” where the tutor must facilitate and develop a continuous process of significance negotiation among the participants.

Beyond providing a whole series of suggestions and rules designed to improve the performance of the new online “teacher”, the authors also indicate the abilities and skills which ought to be developed in order to perform this new profession successfully.

**WILLIAM DRAVES**, *Teaching Online*. Learning Resources Networking, 1999.

“Internet is the biggest technological change in education and learning since the advent of the printed book some 500 years ago. It will destroy the traditional classroom and replace it with an even better way to learn, and to teach. [...] Learners will learn more, while working at their own speed, time and manner, over the Internet. The average class will have 1,000 participants. [...] Learners will come from all over the world, and they will form a *virtual community* that will kindle long-term relationships. *Online learning* will constitute 50% of all learning in the 21<sup>st</sup> century. The Internet will do for our society what the automobile did for it in the last century. And *lifelong learning* is the engine that drives our information age economy”.

William Draves, the veritable “prophet” of *online education* and one of the major experts on *lifelong learning* in the international field, begins his book with these words: he is the President of Learning Resources Networking (LERN), one of the major world associations (4000 members in 15 countries) dealing with adult education in a perspective of lifelong learning.

The text can justly be considered a veritable manual for teachers and the planners of online education courses for adults: the section dedicated to the planning of teaching activities through subdivision into modules is particularly deserving of praise.

**RENA M. PALOFF and KEITH PRATT**, *Building Learning Communities in Cyberspace: Effective Strategies for Online Classrooms*, San Francisco, Jossey-Bass Publishers, 1999.

What are the new features of the virtual classroom? How does the relationship between teacher and students change when the interaction takes place through the use of a screen and a keyboard and they are no longer face-to-face? How can the active involvement of the student in his/her own educational process be developed? And how can the consequent level of learning achieved be evaluated?

In this text the authors, faithful to an educational perspective of a constructivist type, try to present some of the more innovative and promising topics of the new educational paradigm known as online education (or computer-mediated distance education, a term which they prefer). Highlighting the advantages which can be obtained by setting up an



educational environment characterised by collaboration, such as the creation of learning communities, the authors seek to answer these and other crucial questions, while aiming to help the reader understand in what way the new telematic technologies can offer new modes of acquiring knowledge.

**STEVE RYAN, BERNARD SCOTT, HOWARD FREEMAN & DAXA PATEL.** *The Virtual University: the Internet and Resource-based Learning* London, Kogan, 2000.

How is the University changing with the advent of the Internet? What are the advantages and risks that it offers? These are the questions that run through each chapter of this book written by authoritative representatives from the Centre for Educational Technology and Development (CETD) in the Department of Learning Technologies at the De Montfort University of Leicester.

The considerations inevitably raised by online technologies – when the principal aim is to enhance the qualitative value of the education process set in motion – are numerous, but we can at least briefly summarise the four predominant thematic areas upon which the authors focus, or more precisely, the four fields of application which receive greater attention in the modern scenario: *online courses*, *web-based resources*, *computer mediated communication* and *computer aided assessment*. For each of these fields the authors analyse the principal technologies utilised and their specific characteristics, summarising the typologies and providing the criteria for their critical evaluation.

The text is rich in examples and suggestions. There are many references to the net (links) which are presented with the specific aim of allowing the reader to continue his/her own analysis and to investigate the subjects of major interest more thoroughly.